

Easy Script in Python

80000ST10020a Rev.13 – 2010-12-03



APPLICABILITY TABLE

PRODUCT
GT863-PY
GT864-PY
GM862-QUAD-PY
GM862-GPS
GC864-PY
GC864-PY w/ SIM holder
GC864-QUAD-V2
GC864-DUAL-V2
GE863-PY
GE863-GPS
GE863-SIM
GE864-PY
GE864-QUAD-V2
GE864-DUAL-V2
GE864-QUAD Automotive
GE864-QUAD Automotive V2
GE864-QUAD Atex
GE865-QUAD
GL865-DUAL

From SW Versions:

7.03.xx2

10.0x.xx3



Contents

- 1. INTRODUCTION..... 9**
 - 1.1. SCOPE..... 9
 - 1.2. AUDIENCE 9
 - 1.3. CONTACT INFORMATION, SUPPORT 9
 - 1.4. DOCUMENT ORGANIZATION 10
 - 1.5. TEXT CONVENTIONS 10
 - 1.6. RELATED DOCUMENTS 11
 - 1.7. DOCUMENT HISTORY 12
- 2. EASY SCRIPT EXTENSION – PYTHON INTERPRETER..... 14**
 - 2.1. OVERVIEW..... 14
 - 2.2. PYTHON 1.5.2+ COPYRIGHT NOTICE..... 16
 - 2.3. PYTHON INSTALLATION 17
 - 2.4. PYTHON IMPLEMENTATION DESCRIPTION..... 18
 - 2.5. INTRODUCTION TO PYTHON 20
 - 2.5.1. Data types..... 20
 - 2.5.2. Operators..... 21
 - 2.5.3. Compound statements..... 21
 - 2.5.4. Conditional execution..... 22
 - 2.5.5. Loops 22
 - 2.5.6. Resources..... 23
 - 2.6. PYTHON CORE SUPPORTED FEATURES..... 23
- 3. PYTHON BUILT-IN CUSTOM MODULES..... 24**
 - 3.1. CMUX AND PYTHON 24
 - 3.2. MDM BUILT-IN MODULE..... 25
 - 3.2.1. MDM.send(string, timeout)..... 25
 - 3.2.2. MDM.receive(timeout)..... 26
 - 3.2.3. MDM.read()..... 27
 - 3.2.4. MDM.sendbyte(byte, timeout)..... 27
 - 3.2.5. MDM.receivebyte(timeout)..... 27
 - 3.2.6. MDM.readbyte()..... 28
 - 3.2.7. MDM.getDCD()..... 28
 - 3.2.8. MDM.getCTS()..... 28
 - 3.2.9. MDM.getDSR()..... 29
 - 3.2.10. MDM.getRI()..... 29
 - 3.2.11. MDM.setRTS(RTS_value) 29
 - 3.2.12. MDM.setDTR(DTR_value)..... 30
 - 3.3. MDM2 BUILT-IN MODULE..... 31
 - 3.3.1. MDM2.send(string, timeout)..... 31
 - 3.3.2. MDM2.receive(timeout)..... 32
 - 3.3.3. MDM2.read()..... 33
 - 3.3.4. MDM2.sendbyte(byte, timeout)..... 33
 - 3.3.5. MDM2.receivebyte(timeout)..... 34
 - 3.3.6. MDM2.readbyte()..... 34



3.3.7.	<i>MDM2.getDCD()</i>	34
3.3.8.	<i>MDM2.getCTS()</i>	35
3.3.9.	<i>MDM2.getDSR()</i>	35
3.3.10.	<i>MDM2.getRI()</i>	35
3.3.11.	<i>MDM2.setRTS(RTS_value)</i>	36
3.3.12.	<i>MDM2.setDTR(DTR_value)</i>	36
3.4.	SER BUILT-IN MODULE	36
3.4.1.	<i>SER.send(string)</i>	37
3.4.2.	<i>SER.receive(timeout)</i>	37
3.4.3.	<i>SER.read()</i>	38
3.4.4.	<i>SER.sendbyte(byte)</i>	38
3.4.5.	<i>SER.receivebyte(timeout)</i>	39
3.4.6.	<i>SER.readbyte()</i>	39
3.4.7.	<i>SER.set_speed(speed, <char format>)</i>	39
3.4.8.	<i>SER.setDCD(DCD_value)</i>	40
3.4.9.	<i>SER.setCTS(CTS_value)</i>	41
3.4.10.	<i>SER.setDSR(DSR_value)</i>	41
3.4.11.	<i>SER.setRI(RI_value)</i>	41
3.4.12.	<i>SER.getRTS()</i>	42
3.4.13.	<i>SER.getDTR()</i>	42
3.5.	SER2 BUILT-IN MODULE	43
3.5.1.	<i>SER2.send(string)</i>	43
3.5.2.	<i>SER2.receive(timeout)</i>	44
3.5.3.	<i>SER2.read()</i>	44
3.5.4.	<i>SER2.sendbyte(byte)</i>	45
3.5.5.	<i>SER2.receivebyte(timeout)</i>	45
3.5.6.	<i>SER2.readbyte()</i>	46
3.5.7.	<i>SER2.set_speed(speed, <format>)</i>	46
3.6.	GPIO BUILT-IN MODULE	46
3.6.1.	<i>GPIO.setIOvalue(GPIOnumber, value)</i>	47
3.6.2.	<i>GPIO.getIOvalue(GPIOnumber)</i>	47
3.6.3.	<i>GPIO.setIOdir(GPIOnumber, value, direction)</i>	48
3.6.4.	<i>GPIO.getIOdir(GPIOnumber)</i>	48
3.6.5.	<i>GPIO.getADC(adcNumber)</i>	49
3.6.6.	<i>GPIO.setDAC(enable, value)</i> [§]	49
3.6.7.	<i>GPIO.setVAUX(vauxNumber, enable)</i> [§]	49
3.6.8.	<i>GPIO.getAXE()</i> [§]	50
3.6.9.	<i>GPIO.setSLED(status, onDuration, offDuration)</i>	50
3.6.10.	<i>GPIO.getCBC()</i> [§]	51
3.7.	MOD BUILT-IN MODULE	51
3.7.1.	<i>MOD.secCounter()</i>	52
3.7.2.	<i>MOD.sleep(sleeptime)</i>	52
3.7.3.	<i>MOD.watchdogEnable(timeout)</i>	52
3.7.4.	<i>MOD.watchdogReset()</i>	53
3.7.5.	<i>MOD.watchdogDisable()</i>	53
3.7.6.	<i>MOD.powerSaving(timeout)</i>	53
3.7.7.	<i>MOD.powerSavingExitCause()</i>	54



3.7.8.	<i>MOD.encBase64(dataToCode)</i>	54
3.8.	IIC BUILT-IN MODULE	55
3.8.1.	<i>IIC.new(SDA_pin, SCL_pin, <ADDR>)</i>	56
3.8.2.	<i>IIC.init()</i>	56
3.8.3.	<i>IIC.readwrite(string, read_len)</i>	57
3.8.4.	<i>IIC.sendbyte(byte)</i>	58
3.8.5.	<i>IIC.send(string)</i>	58
3.8.6.	<i>IIC.dev_read(addr, len)</i>	59
3.8.7.	<i>IIC.dev_write(addr, string)</i>	59
3.8.8.	<i>IIC.dev_gen_read(addr, start, len)</i>	60
3.8.9.	<i>IIC.dev_gen_write(addr, start, string)</i>	60
3.9.	SPI BUILT-IN MODULE	61
3.9.1.	<i>SPI.new(SCLK_pin, MOSI_pin, MISO_pin, <SS0>, <SS1>, ... <SS7>)</i>	62
3.9.2.	<i>SPI.init(CPOL, CPHA, <SSPOL>, <SS>)</i>	63
3.9.3.	<i>SPI.readwrite(string, <read_len>, <SS>)</i>	64
3.9.4.	<i>SPI.sendbyte(byte, <SS_number>)</i>	66
3.9.5.	<i>SPI.readbyte(<SS_number>)</i>	66
3.9.6.	<i>SPI.send(string, <SS_number>)</i>	67
3.9.7.	<i>SPI.read(len, <SS_number>)</i>	67
3.10.	GPS BUILT-IN MODULE	68
3.10.1.	<i>GPS.powerOnOff(newStatus)</i>	68
3.10.2.	<i>GPS.getPowerOnOff()</i>	69
3.10.3.	<i>GPS.resetMode(mode)</i>	69
3.10.4.	<i>GPS.getAntennaVoltage()</i>	69
3.10.5.	<i>GPS.getAntennaCurrent()</i>	70
3.10.6.	<i>GPS.getActualPosition()</i>	70
3.10.7.	<i>GPS.powerSavingMode(mode, pushToFixPeriod)</i>	70
3.10.8.	<i>GPS.powerSavingWakeUp()</i>	71
3.10.9.	<i>GPS.getLastGGA()</i>	71
3.10.10.	<i>GPS.getLastGLL()</i>	71
3.10.11.	<i>GPS.getLastGSA()</i>	72
3.10.12.	<i>GPS.getLastGSV()</i>	72
3.10.13.	<i>GPS.getLastRMC()</i>	72
3.10.14.	<i>GPS.getLastVTG()</i>	72
3.10.15.	<i>GPS.getPosition()</i>	73
4.	PYTHON SCRIPT OPERATIONS	74
4.1.	EXECUTING A PYTHON SCRIPT.....	74
4.1.1.	<i>Compiling the Python script</i>	75
4.1.2.	<i>Write Python script</i>	76
4.1.3.	<i>Download Python script</i>	76
4.1.4.	<i>Enable Python script</i>	80
4.1.5.	<i>Execute Python script</i>	81
4.1.6.	<i>Reading Python script</i>	81
4.1.7.	<i>List saved Python scripts</i>	82
4.1.8.	<i>Deleting Python script</i>	82
4.1.9.	<i>Restart Python script</i>	82



4.2.	RUN AT INTERFACE AND PYTHON AT THE SAME TIME	83
4.3.	DEBUG PYTHON SCRIPT	84
4.3.1.	<i>Debug Python script on GPS modules using SSC bus.....</i>	<i>84</i>
4.3.2.	<i>Debug Python script on GPS modules using CMUX.....</i>	<i>88</i>
5.	PYTHON STANDARD FUNCTIONS.....	95
5.1.	TECHNICAL CHARACTERISTICS	95
5.1.1.	<i>General.....</i>	<i>95</i>
5.2.	PYTHON SUPPORTED FEATURES	96
5.2.1.	<i>Operators, statements, functions.....</i>	<i>96</i>
5.2.2.	<i>Truth Value Testing.....</i>	<i>97</i>
5.2.3.	<i>Boolean Operations.....</i>	<i>97</i>
5.2.4.	<i>Comparisons.....</i>	<i>97</i>
5.2.5.	<i>Numeric Types: Integers.....</i>	<i>98</i>
5.2.6.	<i>Numeric Types: Long Integers.....</i>	<i>98</i>
5.2.7.	<i>Numeric Types: Float.....</i>	<i>99</i>
5.2.8.	<i>Numeric Types: Complex.....</i>	<i>99</i>
5.2.9.	<i>Sequence Types: Strings.....</i>	<i>99</i>
5.2.10.	<i>Sequence Types: Tuples.....</i>	<i>100</i>
5.2.11.	<i>Sequence Types: Lists.....</i>	<i>100</i>
5.2.12.	<i>Mapping Types: Dictionaries.....</i>	<i>101</i>
5.2.13.	<i>Other Built-in Types: File Objects.....</i>	<i>102</i>
5.2.14.	<i>Other Built-in Types: Modules.....</i>	<i>102</i>
5.2.15.	<i>Other Built-in Types: Classes.....</i>	<i>103</i>
5.2.16.	<i>Other Built-in Types: Functions.....</i>	<i>103</i>
5.2.17.	<i>Other Built-in Types: Methods.....</i>	<i>104</i>
5.2.18.	<i>Other Built-in Types: Type Objects.....</i>	<i>104</i>
5.2.19.	<i>Other Built-in Types: Null Object.....</i>	<i>104</i>
5.2.20.	<i>Other Built-in Types: Ellipsis Object.....</i>	<i>104</i>
5.2.21.	<i>Other Built-in Types: Buffer Objects.....</i>	<i>104</i>
5.2.22.	<i>Other Built-in Types: Range Objects.....</i>	<i>104</i>
5.2.23.	<i>Other Built-in Internal Types: Code Objects.....</i>	<i>105</i>
5.2.24.	<i>Other Built-in Internal Types: Frame Objects.....</i>	<i>105</i>
5.2.25.	<i>Other Built-in Internal Types: Traceback Objects.....</i>	<i>105</i>
5.2.26.	<i>Other Built-in Internal Types: Slice Objects.....</i>	<i>106</i>
5.2.27.	<i>Built-in Exceptions.....</i>	<i>106</i>
5.2.28.	<i>Built-in Functions.....</i>	<i>107</i>
5.2.29.	<i>Built-in Modules: marshal.....</i>	<i>108</i>
5.2.30.	<i>Built-in Modules: imp.....</i>	<i>109</i>
5.2.31.	<i>Built-in Modules: __main__.....</i>	<i>109</i>
5.2.32.	<i>Built-in Modules: __builtin__.....</i>	<i>109</i>
5.2.33.	<i>Built-in Modules: sys.....</i>	<i>110</i>
5.2.34.	<i>Built-in Modules: md5.....</i>	<i>111</i>
5.2.35.	<i>Built-in Modules: binascii.....</i>	<i>111</i>
5.2.36.	<i>Library Modules.....</i>	<i>111</i>
6.	PYTHON NON STANDARD FUNCTIONS	112



Easy Script in Python
80000ST10020a Rev.13 – 2010-12-03

- 6.1. `__BUILTIN__` NON STANDARD FUNCTIONS 112
 - 6.1.1. *Non standard function: unlink* 112
 - 6.1.2. *Non standard function: rename*..... 112
 - 6.1.3. *Non standard function: flashflush* 112
- 7. PYTHON NOTES 113
 - 7.1. MEMORY LIMITS 113
 - 7.2. OTHER LIMITS 115
- 8. LIST OF ACRONYMS 116



DISCLAIMER

The information contained in this document is the proprietary information of Telit Communications S.p.A. and its affiliates ("TELIT"). The contents are confidential and any disclosure to persons other than the officers, employees, agents or subcontractors of the owner or licensee of this document, without the prior written consent of Telit, is strictly prohibited.

Telit makes every effort to ensure the quality of the information it makes available. Notwithstanding the foregoing, Telit does not make any warranty as to the information contained herein, and does not accept any liability for any injury, loss or damage of any kind incurred by use of or reliance upon the information.

Telit disclaims any and all responsibility for the application of the devices characterized in this document, and notes that the application of the device must comply with the safety standards of the applicable country, and where applicable, with the relevant wiring rules.

Telit reserves the right to make modifications, additions and deletions to this document due to typographical errors, inaccurate information, or improvements to programs and/or equipment at any time and without notice. Such changes will, nevertheless be incorporated into new editions of this application note.

Copyright: Transmittal, reproduction, dissemination and/or editing of this document as well as utilization of its contents and communication thereof to others without express authorization are prohibited. Offenders will be held liable for payment of damages. All rights are reserved.

Copyright © Telit Communications SpA 2010.



1. Introduction

1.1. Scope

Aim of this document is to give an overview of the Easy Script Extension feature, which lets the developer to drive the modem *internally*, writing the controlling application directly in a high level language such as Python.

1.2. Audience

This document is intended for Telit customers developing functionalities on their applications.

1.3. Contact Information, Support

For general contact, technical support, to report documentation errors and to order manuals, contact Telit Technical Support Center (TTSC) at:

TS-EMEA@telit.com
TS-NORTHAMERICA@telit.com
TS-LATINAMERICA@telit.com
TS-APAC@telit.com

Alternatively, use:

<http://www.telit.com/en/products/technical-support-center/contact.php>

For detailed information about where you can buy the Telit modules or for recommendations on accessories and components visit:

<http://www.telit.com>

To register for product news and announcements or for product questions contact Telit Technical Support Center (TTSC).

Our aim is to make this guide as helpful as possible. Keep us informed of your comments and suggestions for improvements.

Telit appreciates feedback from the users of our information.



1.4. Document Organization

This document contains the following chapters:

[Chapter 1: "Introduction"](#) provides a scope for this document, target audience, contact and support information, and text conventions.

[Chapter 2: "Easy Script Extension – Python interpreter"](#) gives a broad overview about the extension.

[Chapter 3: "Python built-in custom modules"](#) explains in detail the single custom built-in modules.

[Chapter 4: "Python script operations"](#) deals with the execution of the scripts operatively.

[Chapter 5: "Python standard functions"](#) provides a detailed description of Python language supported features in Data Terminal Modules.

[Chapter 6: "Python non standard functions"](#)

[Chapter 7: "Python notes"](#) deals with some Python limits that should be considered while developing scripts.

1.5. Text Conventions



Danger – This information MUST be followed or catastrophic equipment failure or bodily injury may occur.



Caution or Warning – Alerts the user to important points about integrating the module, if these points are not followed, the module and end user equipment may fail or malfunction.



Tip or Information – Provides advice and suggestions that may be useful when integrating the module.

All dates are in ISO 8601 format, i.e. YYYY-MM-DD.



1.6. Related Documents

- AT Commands Reference guide, 80000ST10025a
- CMUX User Guide, 30268ST10299a



1.7. Document History

Revision	Date	Changes
ISSUE#0	2006-03-21	Release First ISSUE#1
ISSUE#1	2006-09-13	1.4 Python Implementation Description: added SPI and IIC libraries that were missing on the graphic 2.4 MOD built-in module: added Python watchdog and power saving mode 2.5 IIC built-in module: added note for the IIC bus clock frequency 3.9 Debug Python Script: new paragraph for GPS modules - clarified meaning of parameter timeout for the following commands: MDM.receive(timeout), SER.receive(timeout) and SER.receivebyte(timeout)
ISSUE#2	2007-03-16	Added new modules such as: 2.3 MDM2 built-in module 2.5 SER2 built-in module 2.10 GPS built-in module Added new function under IIC and SPI
ISSUE#3	2007-05-24	New disclaimer Added introduction for the new modules in paragraph 1.4 and 2 Introduced new chapter with Python notes
ISSUE#4	2007-09-07	Added products into applicability table
ISSUE#5	2007-10-25	Added list of standard built-in functions
ISSUE#6	2007-12-07	Updated memory limits chapter Added notes for GPIO, IIC and SPI modules
ISSUE#7	2007-12-19	Added new commands under GPIO module Added new paragraph: 3.2Run AT Interface and Python at the same time Added buffer size for MDM and MDM2 send, read, receive commands
ISSUE#8	2008-10-01	Updated new limits in NVM availability for customer's application from SW rel 7.03.x00 Updated version of Python package Updated P/N list
ISSUE#9	2009-01-16	Added GE864-QUAD Automotive to Applicability list Added timeout range in §2.2.1, 2.2.2,2.2.4, 2.2.5, 2.3.1, 2.3.2, 2.3.4, 2.3.5, 2.4.2, 2.4.5, 2.5.2, 2.5.5, 2.7.2, 2.7.3, 2.7.6. Updated §2.8.1 available pins on IIC Updated §2.9.1 available pins on SPI Updated §3.2 about CMUX protocol and AT#CMUXSCR=1.
ISSUE#10	2009-07-03	Applied new layout, shifted chapters numbers by one accordingly Added GE865-QUAD to Applicability Table § 3.3 MDM2 built-in module behavior explanation updated §3.8.1 updated GPIO range available for IIC §3.8.4, §3.8.5, §3.8.6, 3.8.7, 3.8.8, 3.8.9 added note on <i>readwrite</i> command. §3.9.1 updated GPIO available range for SPI.



		§3.9.3 updated explanation and example. Added §6 "Python non standard functions" §7.1 Added suggestion on sleep time after AT#DSCRIPT command
ISSUE #11	2010-04-12	Added par. 3.7.8. Added par. 5.2.35. Modified par. 3.8.1. Modified par. 3.8.3. Modified par. 3.6.3 and 3.6.4. Modified par. 3.2.2, 3.3.2, 3.4.2 and 3.5.2. Modified par. 3.9.1.
ISSUE#12	2010-10-04	Added GL865-DUAL to applicability table
ISSUE#13	2010-12-03	Corrected example in par. 2.5.1



2. Easy Script Extension - Python interpreter

2.1. Overview

The Easy Script Extension is a feature that allows driving the modem *internally*, writing the controlling application directly in the Python high level language. A typical application usually consists of a microcontroller managing several I/O pins on the module through the AT command interface.

A schematic of such a configuration can be the following:

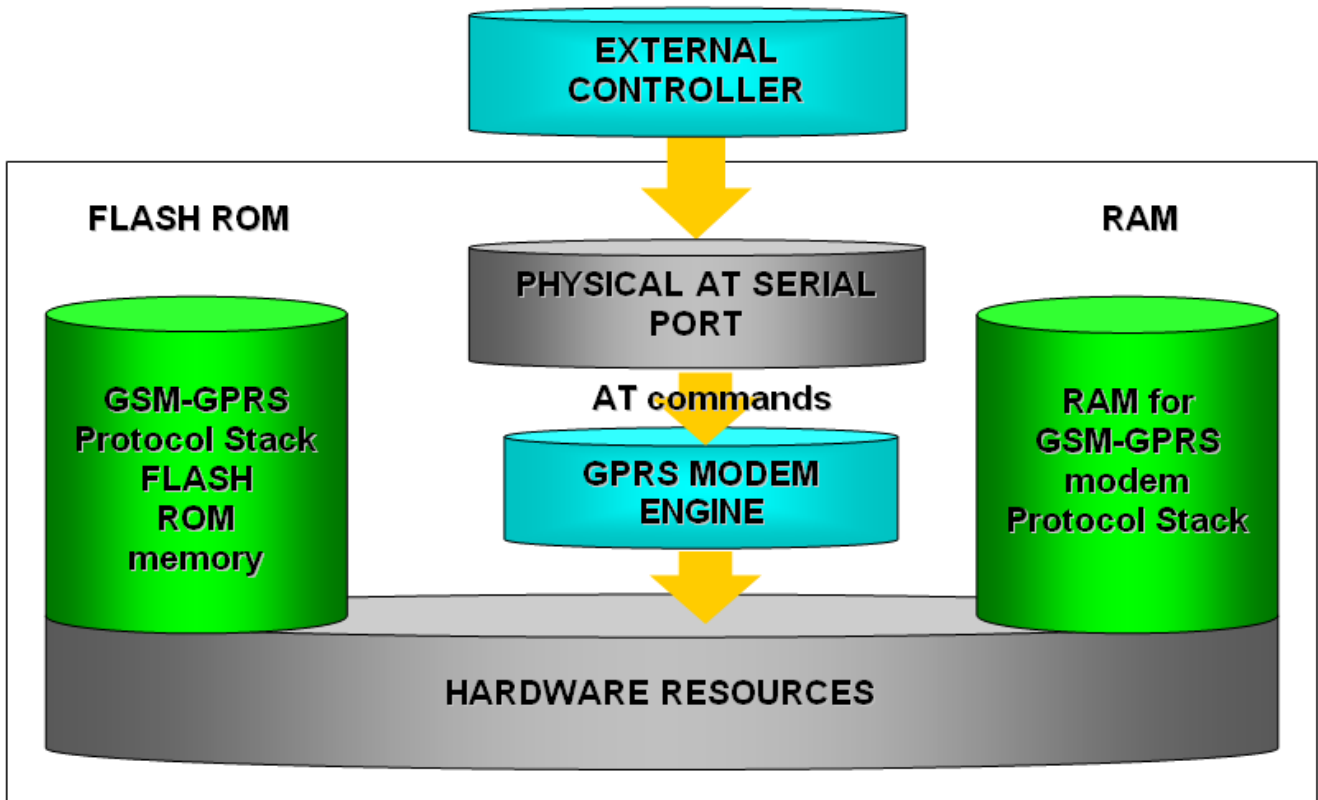

The Easy Script Extension functionality lets the developer to get rid of the external controller and further simplify the programmed sequence of operations. The equipped Python version features the following:

- Python script interpreter engine v. 1.5.2+
- 2MB of Non Volatile Memory space for user scripts and data
- 1.2 MB RAM reserved for the Python engine

The following depicts a schematic of this approach:

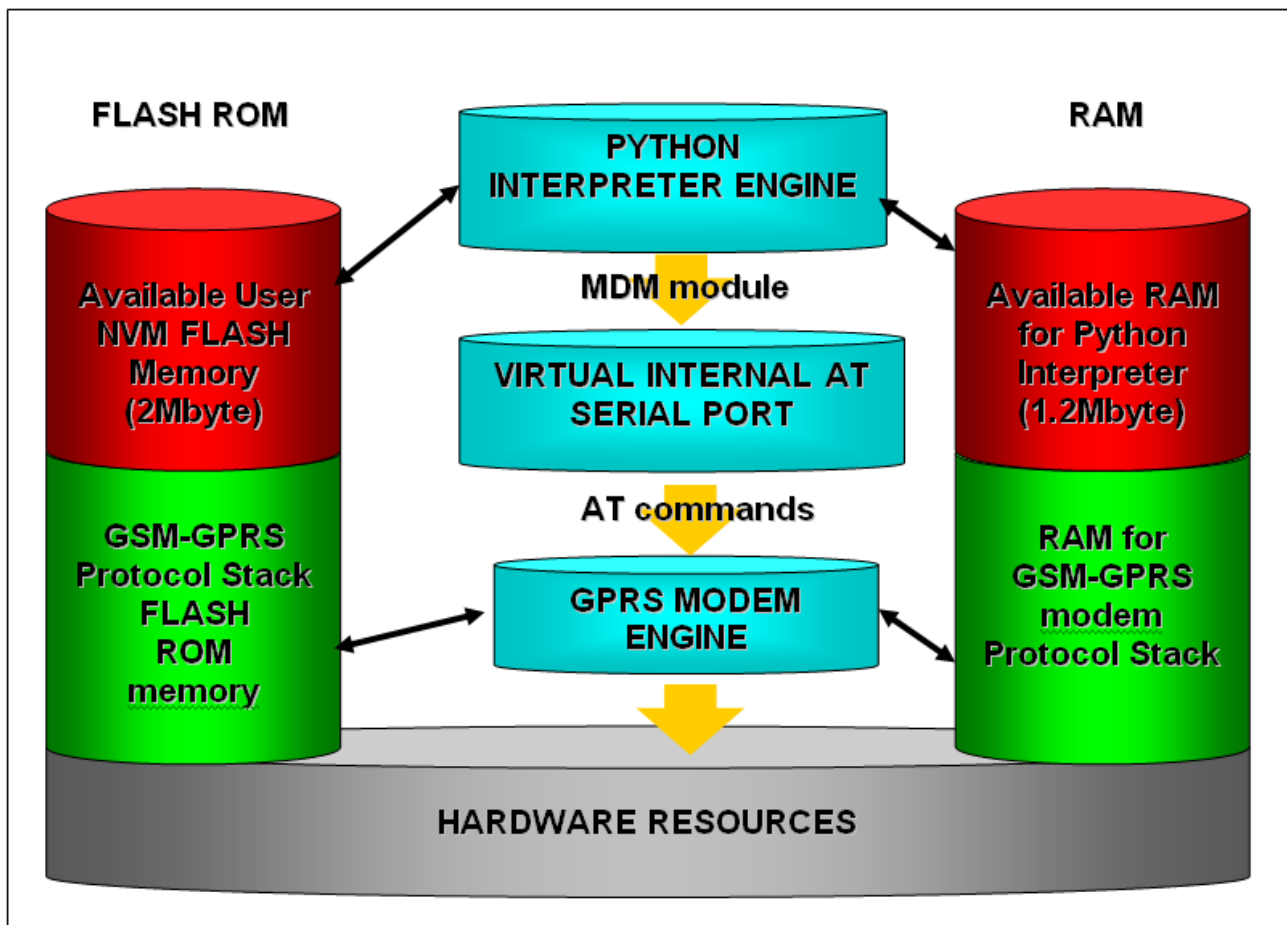

2.2. Python 1.5.2+ Copyright Notice

The Python code implemented into the module is copyrighted by Stichting Mathematisch Centrum, this is the license:

Copyright © 1991-1995 by Stichting Mathematisch Centrum, Amsterdam, The Netherlands.

All Rights Reserved

Copyright © 1995-2001 Corporation for National Research Initiatives; All Rights Reserved.

Copyright (c) 2001-2007 Python Software Foundation; All Rights Reserved.

All Rights Reserved are retained in Python.

Permission to use, copy, modify, and distribute this software and its documentation for any purpose and without fee is hereby granted, provided that the above copyright notice appear in all copies and that both that copyright notice and this permission notice appear in supporting documentation, and that the names of Stichting Mathematisch Centrum or CWI or Corporation for National Research Initiatives or CNRI not be used in advertising or publicity pertaining to distribution of the software without specific, written prior permission.

While CWI is the initial source for this software, a modified version is made available by the Corporation for National Research Initiatives (CNRI) at the Internet address <ftp://ftp.python.org>.

STICHTING MATHEMATISCH CENTRUM AND CNRI DISCLAIM ALL WARRANTIES WITH REGARD TO THIS SOFTWARE, INCLUDING ALL IMPLIED WARRANTIES OF MERCHANTABILITY AND FITNESS, IN NO EVENT SHALL STICHTING MATHEMATISCH CENTRUM OR CNRI BE LIABLE FOR ANY SPECIAL, INDIRECT OR CONSEQUENTIAL DAMAGES OR ANY DAMAGES WHATSOEVER RESULTING FROM LOSS OF USE, DATA OR PROFITS, WHETHER IN AN ACTION OF CONTRACT, NEGLIGENCE OR OTHER TORTIOUS ACTION, ARISING OUT OF OR IN CONNECTION WITH THE USE OR PERFORMANCE OF THIS SOFTWARE.



2.3. Python installation

In order for the software to function correctly, it is required the use of either Windows 2000 or XP as operating systems.

Contact Telit Technical Support to get the latest version of the PythonWin package 1.5.2+.

The latest version available at the time of writing is *TelitPy1.5.2+_V4.1.exe*.

To install the *Telit Python package* you need to execute the executable file *TelitPy1.5.2+_V4.1.exe* and accept the default settings. This will install the Python compiler package. The path to *Telit Python package* will be `C:\Program Files\Python\`, which will be automatically set up in the Windows Environmental variables as well.

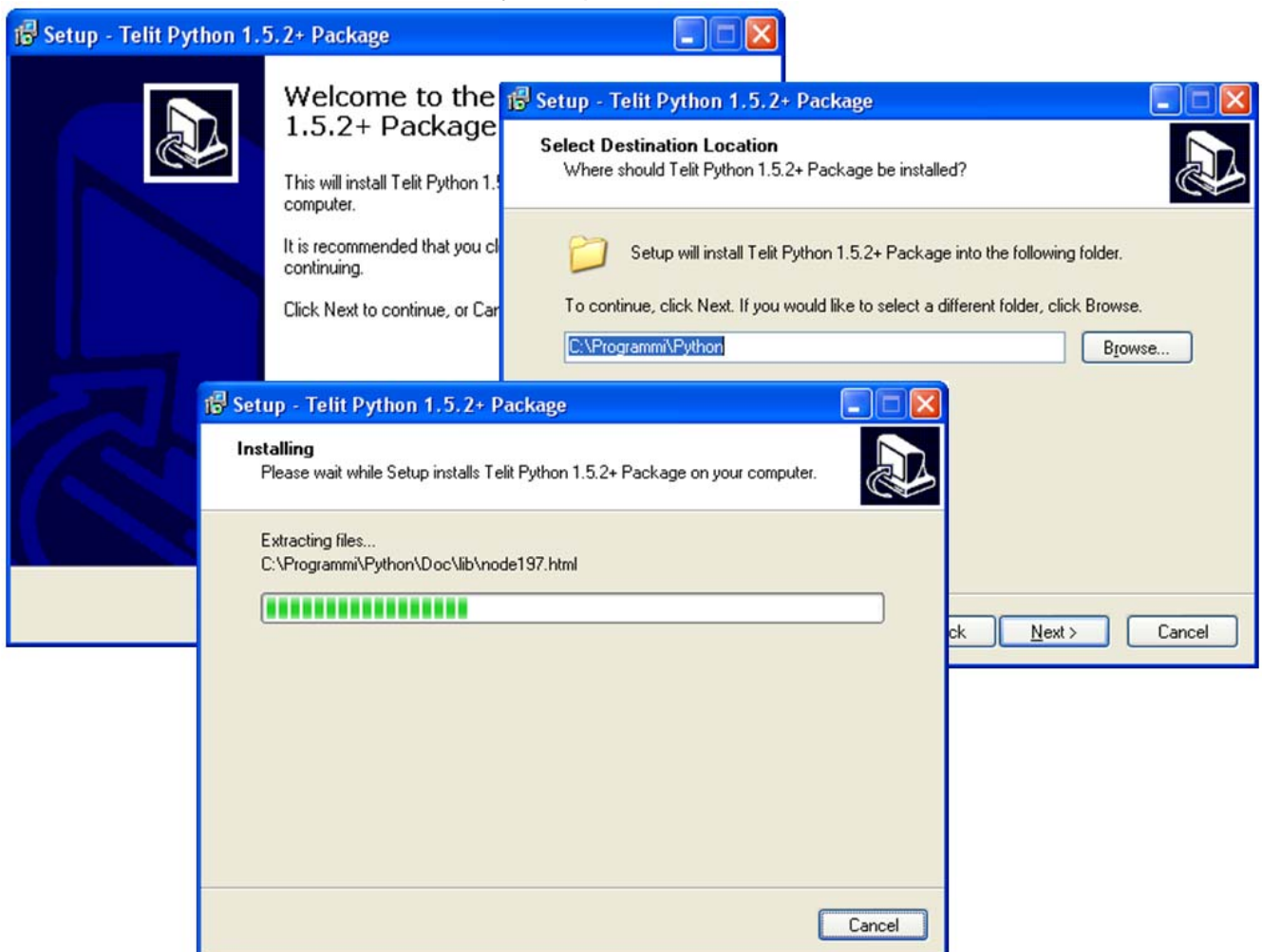

2.4. Python implementation description

Python scripts are text files stored in the **Telit module NVM** (Non Volatile Memory). There's a file system inside the module that allows to write and read files with different names on one single level (no subdirectories are supported).



NOTE:

It is possible to run only one Python script at a time.

The Python script is executed in a task with the lowest priority on the **Telit module**, so it's execution won't interfere with GSM/GPRS normal operations. Furthermore, this allows serial ports, protocol stack etc. to run independently from the Python script. The Python script interacts with the **Telit module** functionalities through several built-in interfaces, as depicted below:

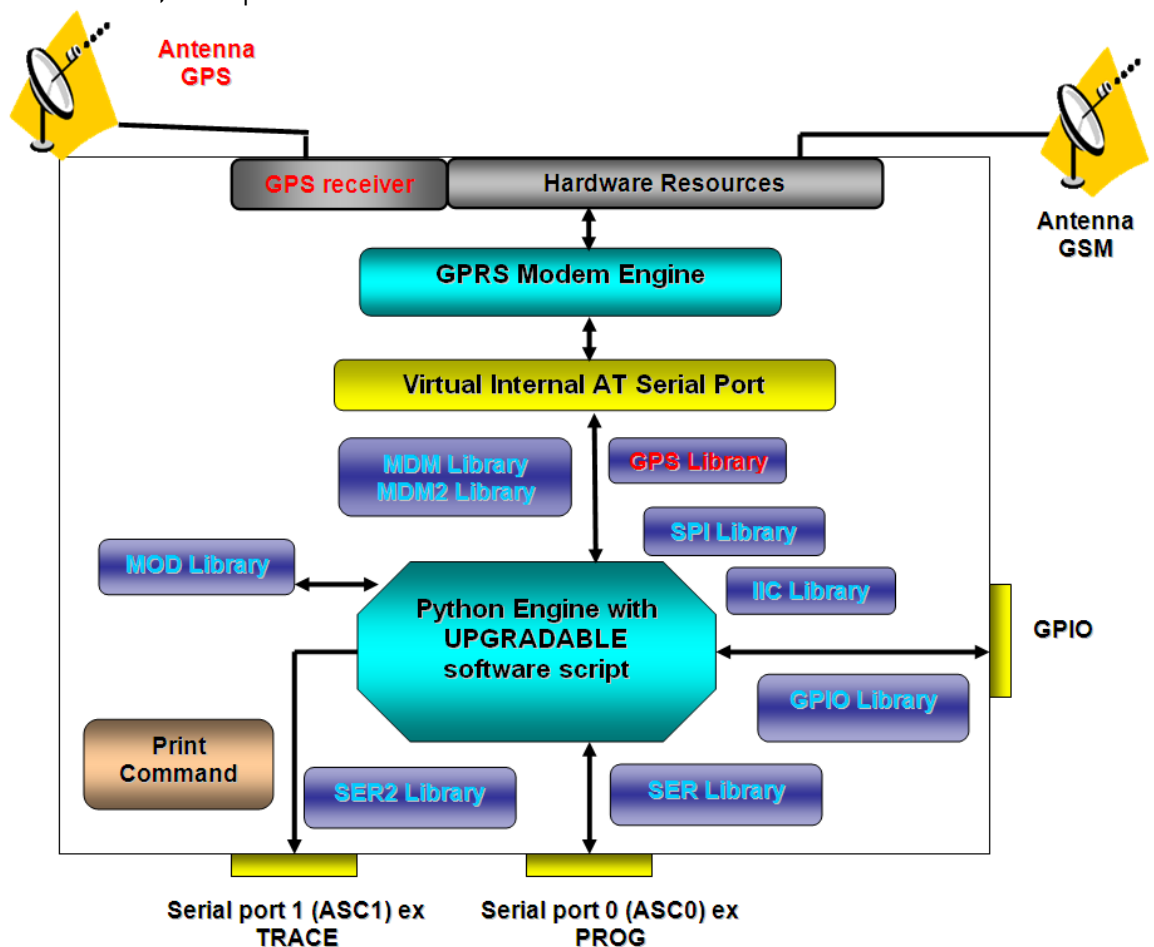



NOTE:

Antenna GPS, GPS receiver and GPS Library are available exclusively for the GPS modules **GM862-GPS** and **GE863-GPS**. Moreover, the SER2 Library cannot be used by GPS modules since their TRACE port is not available.

- **The MDM interface** is the most important one. It allows the Python script to send AT commands, receive responses and unsolicited indications, send data to the network and receive data from the network during connections. It is quite similar to the regular serial port interface on the **Telit module**. The only difference being that this interface is an internal software bridge between Python and module internal AT command handling engine, and not a physical serial port. All AT commands working on the **Telit module** are working with this software interface as well. Some of them have no meaning for this interface, such as those regarding serial port settings, while others, such as the concept of hardware flow control, keeps its meaning but it's managed internally.
- **The MDM2 interface** is the second interface between Python and the module internal AT command handling. It's purpose is to send AT commands from the Python script to the module and receive AT responses from the module to the Python script when the regular MDM built-in module is already in use.
- **The SER interface** lets the Python script to read from and write to the physical serial port ASC0, usually the default port to send AT commands to the module (e.g.: to read information from an external device). When Python is running, this serial port is free to be used by the Python script since it is not used as the AT command interface; the AT parser, in fact, is mapped into the internal virtual serial port. No flow control is available from Python on this port.
- **The SER2 interface** lets the Python script to read from and write to the physical serial port ASC1, usually the default port for tracing and debugging.
- **The GPIO interface** lets the Python script to handle general purpose input output faster than through AT commands, skipping the command parser and controlling directly the pins.
- **The MOD interface** is a collection of useful functions.
- **The IIC interface** is an implementation on the Python core of the IIC bus Master. It allows Python to create one or more IIC bus on the available GPIO pins.
- **The SPI interface** is an implementation on the Python core of the SPI bus Master. It allows Python to create one or more SPI bus on the available GPIO pins.
- **The GPS interface** is the interface between Python and the module's internal GPS controller. Its purpose is to handle the GPS controller without the use of dedicated AT commands through the MDM built-in module.





NOTE:

For debugging purposes, the print command is directly forwarded on the EMMI TX pin (second serial port) at the baud rate of 115200bps 8N1.

2.5. Introduction to Python

Python is a dynamic object-oriented multipurpose high level programming language. It offers strong support for integration featuring several development tools, extensive standard libraries, and can be learned in a matter of days.

2.5.1. Data types

There are three groups of data types in Python:

- Scalars have the subtypes integer, long integer (with an arbitrary number of digits), and strings. For example:

```
i = 1;      li = 9999999999L;  s = 'Hello'
```

- Sequences contain any number of arbitrary objects in a defined order.

```
L = [1, 5, 3, 9, 14];
```

- Associative lists (more commonly known as dictionaries) allow the access to values based on keys. These keys can be arbitrary but uneditable objects. For example:

```
D = {'b': 'Python', 'a': 5};  print D['a']
```

In the above example, the output is 5.

- Unlike Pascal, C, C++ or Java, Python is a dynamically typed language. Thus, the following code is perfectly valid:

```
a = 7                                # 7 (integer)
a = str(2*a) + ' bytes'              # '14 bytes' (string)
```





NOTE:

In Python the variables are not defined in the script, they appear only when used.

2.5.2. Operators

Python has the following operators:

- Arithmetic and bitwise operators

+ - * / % ** ~ << >> & ^ |

- Relational and logical operators

is in < <= > >= == != not and or

- Assignments

= += -= *= /= %= **= <<= >>= &= ^= |=

- Other operators

() [] { } [:] `` . lambda

2.5.3. Compound statements

Statements that belong to the same logical group have the same graphical indentation:

```
if a > 0:  
    b = 1  
    c = 2
```

Usually, each statement starts on a new line.

A statement is continued by putting a backslash \ at the end of the line. This isn't necessary if we're in the middle of parentheses (or brackets or braces):

```
my_list = [1, # open bracket, statement continues  
           ['abc', 2], # nested list  
           -3+6j] # closed outermost bracket, statement ends  
print my_list
```



2.5.4. Conditional execution

Python uses *if*, *elif* (not *elsif* or *elseif*), and *else* to denote conditional execution of statements. For example:

```
if a > b:
    print 'a is greater than b.'
elif a < b:
    print 'a is lower than b.'
else:
    print 'a equals b.'
```

You can use *abbreviated* interval tests:

```
if 2 <= a <= 7:
    print 'a is in the interval [2, 7].'
```

2.5.5. Loops

Loops in Python are defined by the keywords *for* and *while*.

The following example uses a *while* loop to collect all numbers from 0 to 99 in a list.

```
numbers = [ ]
i = 0
while i < 100:
    numbers.append(i)
    i = i + 1      # or i += 1 since Python 2.0
```

A similar *for* loop looks like the following:

```
numbers = [ ]
for i in range(100):
    numbers.append(i)
```

Instead of the explicit loops as above, an implicit loop is possible:

```
numbers = range(100)
```

`range(100)` generates a list of all integers from 0 to 99 (not 100).



2.5.6. Resources

Some useful manuals for Python can be found at the following links:

<http://www.python.org/doc/current/tut/tut.html>

<http://www.hetland.org/python/instant-python.php>

<http://rgruet.free.fr/PQR2.2.html>

2.6. Python core supported features

The Python core version at the time of writing is 1.5.2+ (string methods added to 1.5.2). You can use all Python statements and almost all Python built-in types and functions in your development.

Built-in types and functions not supported	Available modules (all others are not supported)
complex	marshal
float	imp
docstring	<code>_main_</code>
	<code>_builtin_</code>
	sys
	md5
	binascii



3. Python Build-in Custom Modules

Several built-in custom modules have been included in the Python core, specifically developed keeping in mind the hardware environment of the module.

The built-in modules included are:

<i>MDM</i>	interface between Python and the module AT command handling
<i>MDM2</i>	second interface between Python and the module AT command handling
<i>SER</i>	interface between Python and the module serial port ASC0 direct handling
<i>SER2</i>	interface between Python and the module internal serial port ASC1 direct handling
<i>GPIO</i>	interface between Python and the module internal general purpose input output direct handling
<i>MOD</i>	interface between Python and the module miscellaneous functions
<i>IIC</i>	custom Inter IC bus software that can be mapped on creation over almost any GPIO pin available
<i>SPI</i>	custom Serial Protocol Interface bus software that can be mapped on creation over almost any GPIO pin available
<i>GPS</i>	interface between Python and the module internal GPS controller

3.1. CMUX and Python

The CMUX (Converter-Multiplexer) feature has been implemented to ease the use of Python on Telit modules. The Multiplexer mode creates four virtual channels on one serial interface and permits to transmit data to four different applications. This makes it possible to run a Python script and at the same time use CMUX on ASC0 with the following channels division:

- The first CMUX port is reserved for SER module;
- The second CMUX port is available for AT command handling in case of MDM2 built-in module not being imported;
- The third CMUX port is available for AT command handling;
- The fourth CMUX port is used for debug (print statements);





NOTE:

ASC1 is available for non-GPS products importing the SER2 built-in module (see § [3.5](#)).

3.2. MDM built-in module

The MDM built-in module is the interface between Python and the module AT commands parser engine.

You need to use the MDM built-in module if you want to send AT commands and data from the Python script to the network and receive responses and data from the network during connections.

In the default configuration, echo (ATE0) is disabled and the response format of result codes is set to verbose (ATV1).

If you want to use this module you need to *import* it first:

```
import MDM
```

then you can use MDM built-in module methods as in the following example:

```
a = MDM.send('AT', 0)
b = MDM.sendbyte(0x0d, 0)
c = MDM.receive(10)
```

which sends 'AT' and receives 'OK'.

More details about MDM built-in module methods can be found in the following paragraphs.

3.2.1. MDM.send(string, timeout)

This command sends a string to the AT command interface. The first input parameter *string* is a Python string to send to the AT command interface. The second input parameter *timeout* is a Python integer, which is measured in 1/10s, and represents the time to wait for the string to be sent to the AT command interface, with *timeout* as the max value. Waiting time is managed by hardware flow control. This method returns immediately after the string has been sent to the AT interface or after the timeout period if the whole string could not be sent to the AT interface. The timeout range is (0 ÷ 32767). The return value is a Python integer which is -1 if the timeout period has expired, 1 otherwise.

Example:



```
a = MDM.send('AT', 5)
```

sends the string 'AT' to AT command handling, waiting up to 0.5 s, assigning the return value to a.



NOTE:

The buffer available for the MDM.send command is 4096 bytes

3.2.2. MDM.receive(timeout)

This command receives a string from the AT command interface waiting up to the timeout value, a Python value expressed in 1/10s of second. The return value will be the first string received no matter the timeout value. Request to Send (RTS) is set to ON by default. The timeout range is (0 ÷ 32767). The return value is a Python string which contains the data received or is empty if no data is received within the timeout value.

Example:

```
a = MDM.receive(15)
```

Receives a string from AT command handling, waiting up to 1.5 s, assigning the return value to a.



NOTE:

The buffer available to the MDM.receive command is 4096 bytes



NOTE:

For values of timeout greater than 20 (2 seconds) it is suggested to use a Python cycle, MDM.read() method and MOD.secCounter() method. The following is an example:

```
res = ""  
timeout = MOD.secCounter() + TIMEOUT_VALUE  
res = MDM.read()  
while((len(res) == 0) and (MOD.secCounter() < timeout)):  
    res = res + MDM.read()
```



3.2.3. MDM.read()

This command receives a string from the AT command interface without waiting for it. Request to Send (RTS) is set to ON. It has no input parameter. The return value is a Python string which contains the data received at the moment of command execution. The value might be empty if no data is received.

Example:

```
a = MDM.read()
```

Receives a string from AT command handling, assigning the return value to a.



NOTE:

The buffer available for MDM.read command is 4096 bytes⁴

3.2.4. MDM.sendbyte(byte, timeout)

This command sends one byte to the AT command interface. The first input parameter *byte* can be zero or any Python byte to send to the AT command interface. The second input parameter *timeout* is a Python integer, expressed in 1/10 of second, and represents the max time to wait for the byte to be sent to the AT command interface. Waiting time is managed by hardware flow control. This method returns immediately after the byte has been sent to the AT interface or after the timeout period if the byte could not be sent to the AT interface. The timeout range is (0 ÷ 32767).

The return value is a Python integer which is -1 if the timeout expired, 1 otherwise.

Example:

```
b = MDM.sendbyte(0x0d, 0)
```

Sends the byte 0x0d (carriage return <CR>) to the AT commands handling, without waiting and assigning the return value to b.

3.2.5. MDM.receivebyte(timeout)

This command receives one byte from the AT commands interface waiting up to the timeout value. Request to Send (RTS) is set to ON. The input parameter *timeout* is a Python integer which is measured in 1/10s, and represents the maximum amount of time to wait for the byte from the AT command interface. The timeout range is (0 ÷ 32767).



The return value is a Python integer which is the byte value received or -1 if no data is received within the timeout value. The return value can also be zero.

Example:

```
b = MDM2.receivebyte(20)
```

receives a byte from AT command handling, waiting for it up to 2.0 s, assigning the return value to b.

3.2.6. MDM.readbyte()

This command receives a byte from the AT command interface without waiting for it. Request to Send (RTS) is set to ON. It has no input parameter.

The return value is a Python integer which is the byte value received at the moment of command execution or is -1 if no data is received. The return value can also be zero.

Example:

```
b = MDM.readbyte()
```

receives a byte from AT command handling, assigning the return value to b.

3.2.7. MDM.getDCD()

This command gets Carrier Detect (DCD) from the AT command interface. It has no input parameter.

The return value is a Python integer which is either 0 if DCD is OFF or 1 if DCD is ON.

Example:

```
cd = MDM.getDCD()
```

gets DCD from AT command handling, assigning the return value to cd.

3.2.8. MDM.getCTS()

This command gets Clear to Send (CTS) from the AT command interface. It has no input parameter.

The return value is a Python integer which is either 0 if CTS is set to OFF or 1 if CTS is set to ON.

Example:



```
cts = MDM.getCTS()
```

gets CTS from AT command handling, assigning the return value to cts.

3.2.9. MDM.getDSR()

This command gets Data Set Ready (DSR) from the AT command interface. It has no input parameter.

The return value is a Python integer which is either 0 if DSR is OFF or 1 if DSR is ON.

Example:

```
dsr = MDM.getDSR()
```

gets DSR from AT command handling, assigning the return value to dsr.

3.2.10. MDM.getRI()

This command gets Ring Indicator (RI) from the AT command interface. It has no input parameter.

The return value is a Python integer which is either 0 if RI is set to OFF or 1 if RI is set to ON.

Example:

```
ri = MDM.getRI()
```

gets RI from AT command handling, assigning the return value to ri.

3.2.11. MDM.setRTS(RTS_value)

This command sets Request to Send (RTS) in the AT command interface. The input parameter *RTS_value* is a Python integer which is either 0 if setting RTS to OFF or 1 if setting RTS to ON.

No return value.

Example:

```
MDM.setRTS(1)
```

sets RTS to ON in AT command handling.



3.2.12. MDM.setDTR(DTR_value)

This command sets Data Terminal Ready (DTR) in the AT command interface. The input parameter *DTR_value* is a Python integer which is either 0 if setting DTR to OFF or 1 if setting DTR to ON.

No return value.

Example:

```
MDM.setDTR(0)
```

sets DTR to OFF in AT command handling.



3.3. MDM2 built-in module

MDM2 built-in module is the second interface between Python and the module internal AT command handling. It is used to send AT commands from Python script to module and receive AT responses from module to Python script when the classic MDM built-in module already in use.

MDM2 built-in module is independent from activation of CMUX on ASC0. In case you have enabled CMUX on ASC0 (AT#CMUXSCR=1) then the second CMUX port will be dedicated to MDM2 and no AT command handling will be possible on that port. Remember that first CMUX port is reserved for SER module and fourth CMUX port is in use for debug (print statements).

Though MDM2 built-in module is independent from activation of CMUX on ASC0, it works on the second instance of AT parser in the same way the second CMUX port does. So the rules on AT commands that apply on the first and second CMUX ports (AT parser instances) apply on MDM and MDM2 as well.

See "AT Commands Reference Guide" and "CMUX User Guide" for details on availability of AT commands on all instances and for the rules on parallel execution of AT commands on two instances.

In the default configuration, echo (ATE0) is disabled and the response format of result codes is set to verbose (ATV1).

If you want to use MDM2 built-in module you need to import it first:

```
import MDM2
```

than you can use MDM2 built-in module methods like in the following example:

```
a = MDM2.send('AT', 0)
b = MDM2.sendbyte(0x0d, 0)
c = MDM2.receive(10)
```

which sends 'AT' and receives 'OK'.

More details about MDM2 built-in module methods can be found in the following paragraphs.

3.3.1. MDM2.send(string, timeout)



This command sends a string to the AT command interface. The first input parameter *string* is a Python string that will be send to the AT command interface. The second input parameter *timeout* is a Python integer which is measured in 1/10s, and represents the time of waiting for the string to be sent to the AT command interface, with maximum value of *timeout*. Waiting time is managed by hardware flow control. This method returns immediately after the string has been sent to the AT interface or after the timeout period if the whole string could be sent to the AT interface. The timeout range is (0 ÷ 32767).

The return value is a Python integer which is -1 if timeout expired otherwise is 1.

Example:

```
a = MDM2.send('AT', 5)
```

sends string 'AT' to AT command handling, possibly waiting for 0.5 s, assigning the return value to a.



NOTE:

The buffer available for MDM.send command is 4096 bytes

3.3.2. MDM2.receive(timeout)

This command receives a string from the AT command interface waiting for it until timeout is expired. The return value will be the first string received no matter of how long the timeout is. Request to Send (RTS) is set to ON. The input parameter *timeout* is a Python integer, which is measured in 1/10s, and represents the max time to wait for the string from the AT command interface. The timeout range is (0 ÷ 32767).

The return value is a Python string which is an empty string if *timeout* has expired without any data received otherwise the string contains data received.

Example:

```
a = MDM2.receive(15)
```

receives a string from AT command handling, possibly waiting for it for 1.5 s, assigning the return value to a.



NOTE:

The buffer available for MDM2.receive command is 4096 bytes.





NOTE:

For values of timeout greater than 20 (2 seconds) it is suggested to use a Python cycle, MDM2.read() method and MOD.secCounter() method. The following is an example:

```
res = ""
timeout = MOD.secCounter() + TIMEOUT_VALUE
res = MDM2.read()
while((len(res) == 0) and (MOD.secCounter() < timeout)):
    res = res + MDM2.read()
```

3.3.3. MDM2.read()

This command receives a string from the AT command interface without waiting for it. Request to Send (RTS) is set to ON. It has no input parameter.

The return value is a Python string which is an empty string if no data received otherwise the string contains data received in the moment when command is activated.

Example:

```
a = MDM2.read()
```

receives a string from AT command handling, assigning the return value to a.



NOTE:

The buffer available for MDM2.read command is 4096 bytes

3.3.4. MDM2.sendbyte(byte, timeout)

This command sends a byte to the AT command interface. The first input parameter *byte* is any Python byte that will be to send to the AT command interface. It can also be zero.

The second input parameter *timeout* is a Python integer which is the value in 1/10 s to wait for the byte to be sent to the AT command interface before timeout expires. Waiting time is managed by hardware flow control. This method returns immediately after the byte has been sent to the AT interface or after the timeout period if the byte could not be sent to the AT interface. The timeout range is (0 ÷ 32767).

The return value is a Python integer which is -1 if timeout expired otherwise is 1.



Example:

```
b = MDM2.sendbyte(0x0d, 0)
```

sends byte 0x0d, that is <CR>, to AT command handling, without waiting, assigning the return value to b.

3.3.5. MDM2.receivebyte(timeout)

This command receives a byte from the AT command interface up to the timeout value. Request to Send (RTS) is set to ON. The input parameter *timeout* is a Python integer which is measured in 1/10s, and represents the max time to wait for the string from the AT command interface. The timeout range is (0 ÷ 32767).

The return value is a Python integer which is the byte value received or -1 if no data is received within the timeout value. The return value can also be zero.

Example:

```
b = MDM2.receivebyte(20)
```

receives a byte from AT command handling, possibly waiting for it for 2.0 s, assigning the return value to b.

3.3.6. MDM2.readbyte()

This command receives a byte from the AT command interface without waiting for it. Request to Send (RTS) is set to ON. It has no input parameter.

The return value is a Python integer which is - the byte value received or -1 if no data is received within the timeout value. The return value can also be zero.

Example:

```
b = MDM2.readbyte()
```

receives a byte from AT command handling, assigning the return value to b.

3.3.7. MDM2.getDCD()

This command gets Carrier Detect (DCD) from the AT command interface. It has no input parameter.



The return value is a Python integer which is 0 if DCD is set to OFF or 1 if DCD is set to ON.

Example:

```
cd = MDM2.getDCD()
```

gets DCD from AT command handling, assigning the return value to cd.

3.3.8. MDM2.getCTS()

This command gets Clear to Send (CTS) from the AT command interface. It has no input parameter.

The return value is a Python integer which is either 0 if CTS is set to OFF or 1 if CTS is set to ON.

Example:

```
cts = MDM2.getCTS()
```

gets CTS from AT command handling, assigning the return value to cts.

3.3.9. MDM2.getDSR()

This command gets Data Set Ready (DSR) from the AT command interface. It has no input parameter.

The return value is a Python integer which is either 0 if DSR is set to OFF or 1 if DSR is set to ON.

Example:

```
dsr = MDM2.getDSR()
```

gets DSR from AT command handling, assigning the return value to dsr.

3.3.10. MDM2.getRI()

This command gets Ring Indicator (RI) from the AT command interface. It has no input parameter.

The return value is a Python integer which is 0 if RI is set to OFF or 1 if RI is set to ON.



Example:

```
ri = MDM2.getRI()
```

gets RI from AT command handling, assigning the return value to ri.

3.3.11. MDM2.setRTS(RTS_value)

This command sets Request to Send (RTS) in the AT command interface. The input parameter *RTS_value* is a Python integer which is 0 if setting RTS to set to OFF or 1 if setting RTS to set to ON.

It has no return value.

Example:

```
MDM2.setRTS(1)
```

sets RTS to ON in AT command handling.

3.3.12. MDM2.setDTR(DTR_value)

This command sets Data Terminal Ready (DTR) in the AT command interface. The input parameter *DTR_value* is a Python integer which is 0 if setting DTR to set to OFF or 1 if setting DTR to set to ON.

It has no return value.

Example:

```
MDM2.setDTR(0)
```

sets DTR to OFF in AT command handling.

3.4. SER built-in module

The SER built-in module is an interface between the Python core and the device serial port over the RXD/TXD pins direct handling. You need to use the SER built-in module if you want to send data from the Python script to the serial port and to receive data from the serial port ASC0 to the Python script. This serial port handling module can be used, for example, to interface the module with an external device (such as a GPS) and



read/send its data (e.g. NMEA). The SER built-in module has also been lately improved with the possibility to control physical lines.

If you want to use SER built-in module you need to import it:

```
import SER
```

then you can use its methods, like in the following example:

```
a = SER.set_speed('9600')  
b = SER.send('test')  
c = SER.sendbyte(0x0d)  
d = SER.receive(10)
```

which sends 'test' followed by <CR> and receives data waiting for 1 second.

More details about SER built-in module methods can be found in the following paragraphs.

3.4.1. SER.send(string)

This command sends a string to the serial port TXD/RXD. The input parameter *string* is a Python string that will be sent to the serial port ASC0.

The return value is a Python integer which is -1 if an error occurred otherwise is 1.

Example:

```
a = SER.send('test')
```

sends the string 'test' to the serial port ASC0 handling, assigning the return value to a.



NOTE:

the buffer available for the SER.send(string) command is 4096 bytes

3.4.2. SER.receive(timeout)

This command receives a string from the serial port TXD/RXD waiting for it until the timeout is expired. The return value will be the first string received no matter of how long the timeout is. The input parameter *timeout* is a Python integer, which is measured in 1/10s, and represents the max time to wait for the string from the serial port ASC0. The timeout range is (0 ÷ 32767).

The return value is a Python string which is an empty string if *timeout* expired without any data received, otherwise it is the string consisting in the data received.



Example:

```
a = SER.receive(15)
```

receives a string from serial port ASC0 handling, waiting for it up to 1.5 s, assigning the return value to a.



NOTE:

For values of timeout greater than 20 (2 seconds) it is suggested to use a Python cycle, SER.read() method and MOD.secCounter() method. The following is an example:

```
res = ""  
timeout = MOD.secCounter() + TIMEOUT_VALUE  
res = SER.read()  
while((len(res) == 0) and (MOD.secCounter() < timeout)):  
  res = res + SER.read()
```

3.4.3. SER.read()

This command receives a string from the serial port TXD/RXD without waiting for it. It has no input parameter. The return value is a Python string which is an empty string if no data received, otherwise it is the string containing the data received at command execution time.

Example:

```
a = SER.read()
```

receives a string from the serial port ASC0 handling, assigning the return value to a.



NOTE:

the buffer available for the SER.receive(timeout) and SER.read() commands is 4096 bytes.

3.4.4. SER.sendbyte(byte)

This command sends a byte to the serial port TXD/RXD. The input parameter *byte* is any Python byte that will be sent to the serial port. It can also be zero.
The return value is a Python integer which is -1 if an error occurred otherwise is 1.



Example:

```
b = SER.sendbyte(0x0d)
```

sends the byte 0x0d, that corresponds to <CR>, to the serial port ASC0 handling, assigning the return value to b.

3.4.5. SER.receivebyte(timeout)

This command receives a byte from the serial port TXD/RXD waiting for it until the timeout is expired. The return value will be the first byte received no matter of how long the timeout is. The input parameter *timeout* is a Python integer, which is measured in 1/10s, and represents the max time to wait for the string from serial port ASC0. The timeout range is (0 ÷ 32767).

The return value is a Python integer which is -1 if timeout expired without any data received otherwise is the byte value received. It can also be zero.

Example:

```
b = SER.receivebyte(20)
```

receives a byte from serial port ASC0 handling, waiting for it for 2.0 s, assigning the return value to b.

3.4.6. SER.readbyte()

This command receives a byte from the serial port TXD/RXD without waiting for it. It has no input parameter.

The return value is a Python integer which is -1 if no data received, otherwise is the byte value received. It can also be zero.

Example:

```
b = SER.readbyte()
```

receives a byte from serial port ASC0 handling, assigning the return value to b.

3.4.7. SER.set_speed(speed, <char format>)

This command sets the serial port TXD/RXD speed. The default serial port TXD/RXD speed is 9600. The input parameter *speed* is a Python string which is the value of the serial port speed. It can assume the same values as the +IPR command.



NOTE:

sending the +IPR command to the device does not affect the physical serial port, you must use this function to set the speed of the port when using the Python engine.

The optional parameter *<char format>* is a Python string that represents the character format to be used:
the first is the number of bits per char (7 or 8), then the parity setting (N - none, E- even, O- odd) and the number of stop bits (1 or 2). The default value is "8N1".
The return value is a Python integer which is -1 if an error occurred otherwise is 1.

Example:

```
b = SER.set_speed('115200')
```

sets the serial port ASC0 speed to 115200, assigning the return value to b.



NOTE:

for the PythonWin version previous to *TelitPy1.5.2+_V2.1.exe* and for version of Python on the module previous to Ver6.03.000, a different syntax is implemented depending on the development environment.

- PythonWin application: `SER.SetSpeed(speed)` without *char format* parameter.
 - Python installed on module: `SER.set_speed(speed, char format)` with *char format* not an optional parameter.
-

3.4.8. SER.setDCD(DCD_value)

This command sets Carrier Detect (DCD) on the serial port ASC0. The input parameter *DCD_value* is a Python integer which is either 0 if DCD is set to OFF or 1 if DCD is set to ON. It has no return value.

Example:

```
SER.setDCD(1)
```

sets DCD to ON in ASC0.



3.4.9. SER.setCTS(CTS_value)

This command sets Clear to Send (CTS) on the serial port ASC0. The input parameter *CTS_value* is a Python integer which is either 0 if CTS is set to OFF or 1 if CTS is set to ON.

It has no return value.

Example:

```
SER.setCTS(1)
```

sets CTS to ON in ASC0.

3.4.10. SER.setDSR(DSR_value)

This command sets Data Set Ready (DSR) on the serial port ASC0. The input parameter *DSR_value* is a Python integer which is either 0 if DSR is set to OFF or 1 if DSR is set to ON. It has no return value.

Example:

```
SER.setDSR(1)
```

sets DSR to ON in ASC0.

3.4.11. SER.setRI(RI_value)

This command sets Ring Indicator (RI) on the serial port ASC0. The input parameter *RI_value* is a Python integer which is either 0 if RI is set to OFF or 1 if RI is set to ON. It has no return value.

Example:

```
SER.setRI(1)
```

sets RI to ON in ASC0.



3.4.12. SER.getRTS()

This command gets Request to Send (RTS) from the serial port ASC0. It has no input parameter.

The return value is a Python integer which is either 0 if RTS is set to OFF or 1 if RTS is set to ON.

Example:

```
rts = SER.getRTS()
```

gets RTS from ASC0, assigning the return value to rts.

3.4.13. SER.getDTR()

This command gets Data Terminal Ready (DTR) from the serial port ASC0. It has no input parameter.

The return value is a Python integer which is either 0 if DTR is set to OFF or 1 if DTR is set to ON.

Example:

```
dtr = SER.getDTR()
```

gets DTR from ASC0, assigning the return value to dtr.



3.5. SER2 built-in module

The SER2 built-in module is the interface between Python and the module internal serial port ASC1 direct handling. It is used to send data from the Python script to the serial port ASC1 and to receive data from the serial port ASC1 to the Python script.



NOTE:

The SER2 built-in module is available only for non-GPS products.

If you want to use the SER2 built-in module you need to import it first:

```
import SER2
```

than you can use SER2 built-in module methods like in the following example:

```
a = SER2.send('test')
b = SER2.sendbyte(0x0d)
c = SER2.receive(10)
```

which sends 'test' followed by <CR> and receives data waiting for one second. More details about SER2 built-in module methods can be found the following paragraphs.

When the SER2 bulit-in module is imported, ASC1 will not be available for trace and debug; in order to have these functionalities you should activate CMUX on ASC0. If you are using CMUX on ASC0 (AT#CMUXSCR=1) then the fourth CMUX port will be available for trace and debug.

3.5.1. SER2.send(string)

This command sends a string to the serial port ASC1. The input parameter *string* is a Python string that will be send to serial port ASC1.

The return value is a Python integer which is either -1 if an error occurred otherwise is 1.

Example:

```
a = SER2.send('test')
```



sends string 'test' to serial port ASC1 handling, assigning the return value to a.



NOTE:

The buffer available for the SER2.send command is 4096 bytes.

3.5.2. SER2.receive(timeout)

This command receives a string from the serial port ASC1 waiting for it until timeout is expired. The return value will be the first string received no matter of how long the timeout is. The input parameter *timeout* is a Python integer, which is measured in 1/10s, and represents the max time to wait for the string from the serial port ASC1. The timeout range is (0 ÷ 32767).

The return value is a Python string which is an empty string if the timeout expired without any data received, otherwise it is the string consisting in the data received.

Example:

```
a = SER2.receive(15)
```

receives a string from the serial port ASC1 handling, waiting for it up to 1.5 s, assigning the return value to a.



NOTE:

For values of timeout greater than 20 (2 seconds) it is suggested to use a Python cycle, SER2.read() method and MOD.secCounter() method. The following is an example:

```
res = ""
timeout = MOD.secCounter() + TIMEOUT_VALUE
res = SER2.read()
while((len(res) == 0) and (MOD.secCounter() < timeout)):
    res = res + SER2.read()
```

3.5.3. SER2.read()

This command receives a string from the serial port ASC1 without waiting for it. It has no input parameter.



The return value is a Python string which is an empty string if no data was received, otherwise it is the string containing the data received at command execution time.

Example:

```
a = SER2.read()
```

receives a string from the serial port ASC1 handling, assigning the return value to a.



NOTE:

the buffer available for the SER2.receive(timeout) and SER2.read() commands is 4096 bytes.

3.5.4. SER2.sendbyte(byte)

This command sends a byte to the serial port ASC1. The input parameter *byte* is any Python byte that will be sent to the serial port ASC1. It can also be zero. The return value is a Python integer which is -1 if an error occurred otherwise it is 1.

Example:

```
b = SER2.sendbyte(0x0d)
```

sends the byte 0x0d, that corresponds to <CR>, to the serial port ASC1 handling, assigning the return value to b.

3.5.5. SER2.receivebyte(timeout)

This command receives a byte from the serial port ASC1 waiting for it until the timeout is expired. The return value will be the first byte received no matter of how long the timeout is. The input parameter *timeout* is a Python integer which is measured in 1/10s, and represents the max time to wait for the string from the serial port ASC1. The timeout range is (0 ÷ 32767).

The return value is a Python integer which is -1 if timeout expired without any data received otherwise it is the byte value received. It can also be zero.

Example:

```
b = SER2.receivebyte(20)
```



receives a byte from serial port ASC1 handling, waiting for it for 2.0 s, assigning the return value to b.

3.5.6. SER2.readbyte()

This command receives a byte from the serial port ASC1 without waiting for it. It has no input parameter.

The return value is a Python integer which is -1 if no data was received, otherwise it is the byte value received. It can also be zero.

Example:

```
b = SER2.readbyte()
```

receives a byte from the serial port ASC1 handling, assigning the return value to b.

3.5.7. SER2.set_speed(speed, <format>)

This command sets the serial port ASC1 speed. The default ASC1 serial port speed is 9600. The first input parameter *speed* is a Python string which is the value of the serial port speed. It can be in the range from '300' to '115200'. The second input parameter *format* is optional and is a Python string which is the serial port format. It can be '8N1', '8N2', '8E1', '8O1', '7N1', '7N2', '7E1', '7O1', or '8E2'.

The return value is a Python integer which is -1 if an error occurred otherwise is 1.

Example:

```
b = SER2.set_speed('115200')
```

sets serial port ASC1 speed to 115200, assigning the return value to b.

3.6. GPIO built-in module



The GPIO built-in module¹ is an interface between the Python core and the module internal general purpose input output direct handling. The GPIO built-in module is used to set GPIO values from the Python script and to read GPIO values from the Python script. You can control the GPIO pins also by sending internal 'AT#GPIO' commands using the MDM module, but using the GPIO module is faster because no command parsing is involved, therefore its use is recommended.



NOTE:

The Python core does not verify if the pins are already used for other purposes (IIC module or SPI module) by other functions, it's the customer responsibility to ensure that no conflict over pins occurs.

If you want to use the GPIO built-in module you need to import it first:

```
import GPIO
```

then you can use its methods as in the following example:

```
a = GPIO.getIOvalue(5)
b = GPIO.setIOvalue(4, 1)
```

this reads the GPIO 5 value and sets GPIO 4 to the output with value 1.

More details about GPIO built-in module methods are in the following paragraphs.

3.6.1. GPIO.setIOvalue(GPIOnumber, value)

Sets the output value of a GPIO pin. The first input parameter *GPIOnumber* is a Python integer which is the number of the GPIO. The second input parameter *value* is a Python integer which is the output value. It can be 0 or 1.

The return value is a Python integer which is -1 if an error occurred otherwise is 1.

Example:

```
b = GPIO.setIOvalue(4, 1)
```

sets GPIO 4 to output with value 1, assigning the return value to b.

3.6.2. GPIO.getIOvalue(GPIOnumber)

This method is used to get the input or output value of a GPIO. The input parameter *GPIOnumber* is a Python integer which is the number of the GPIO.

¹ Note: In case of a data call, PythonWin simulates the GPIO with dummy commands.



The return value is a Python integer which is -1 if an error occurred otherwise it is the input or output value. It can be either 0 or 1.

Example:

```
b = GPIO.getIOvalue(5)
```

gets the GPIO 5 input or output value, assigning the return value to b.

3.6.3. GPIO.setIODir(GPIOnumber, value, direction)

This method is used to set the direction of a GPIO. The first input parameter *GPIOnumber* is a Python integer which is the number of the GPIO. The second input parameter *value* is a Python integer which is the output value. It can be either 0 or 1. It is only used if the *direction* value is 1.



NOTE:

when the *direction* value is not 1, although the parameter *value* has no meaning, it is necessary to assign it one of the two possible values: 0 or 1

The third input parameter *direction* is a Python integer which is the direction value. It can be either 0 for input or 1 for output or 2 for alternate function or 3 for tristate pull down. Refer to AT#GPIO command in "AT Commands Reference Guide" for further notes.

The return value is a Python integer which is -1 if an error occurred otherwise is 1.

Example:

```
c = GPIO.setIODir(4, 0, 0)
```

sets GPIO 4 to input with the *value* parameter having no meaning, and assigning the return value to c.

3.6.4. GPIO.getIODir(GPIOnumber)

This method gets the direction of a GPIO. The input parameter *GPIOnumber* is a Python integer which is the number of the GPIO.

The return value is a Python integer which is -1 if an error occurred otherwise is direction value. It is 0 for input or 1 for output or 2 for alternate function or 3 for tristate pull down.

Example:



```
d = GPIO.getIODir(7)
```

gets GPIO 7 direction, assigning the return value to d.

3.6.5. GPIO.getADC(adcNumber)

This method gets ADC value in the same way as AT#ADC command. The input parameter *adcNumber* is a Python integer which represents the ADC number that will be read and converted in voltage.

The return value is a Python integer which is -1 if an error occurred otherwise the converted voltage is returned in mV.

Example:

```
mV = GPIO.getADC(2)
```

gets ADC number 2 input voltage, assigning the return value in mV.

3.6.6. GPIO.setDAC(enable, value)⁸

This method sets the DAC value in the same way as the AT#DAC command. The first input parameter *enable* is a Python integer and can assume values 0 or 1. If it is set to 1 enables DAC output otherwise if it is set to 0 disabled DAC output. The second input parameter *value* is a Python integer and represents the scale factor of output voltage and can assume values in the range 0-1023.

The return value is a Python integer that has value -1 if an error occurred otherwise it has value 1.

Example:

```
res = GPIO.setDAC(1, 512)
```

sets DAC output voltage at half the range, assigning the return value to res.

3.6.7. GPIO.setVAUX(vauxNumber, enable)⁸

This method enables or disables the VAUX. It is equivalent to the AT#VAUX command. The first input parameter *vauxNumber* is a Python integer that represents VUAX number that will be enabled or disabled.

The second input parameter *enable* is a Python integer that can assume value 1 in order to enable VAUX output or 0 if VAUX output should be disabled.



The return value is a Python integer that has value -1 if an error occurred otherwise it has the value 1.

Example:

```
res = GPIO.setVAUX(1, 1)
```

enables VAUX number 1 output, assigning the return value to res.

3.6.8.

GPIO.getAXE()⁹

This method is used to get the hands free status value. It is equivalent to the AT#AXE command. There is no input parameter.

The return value is a Python integer that is either 0 if a hand free is not connected or 1 if a hand free is connected.

Example:

```
hf = GPIO.getAXE()
```

gets the AXE value, assigning the return value to hf.

3.6.9. GPIO.setSLED(status, onDuration, offDuration)

Sets the status led configuration values. IT is equivalent to the AT#SLED command. The first input parameter *status* is a Python integer that represents the configuration of status led and can assume the following values:

- 0 - ALWAYS OFF
- 1 - ALWAYS ON
- 2 - AUTO
- 3 - BLINKING

The second input parameter *onDuration* is a Python integer which is the period of ON configuration of status led in 1/10 s. The third input parameter *offDuration* is a Python integer which is the period of OFF configuration of status led in 1/10 s.

The return value is a Python integer which is -1 if an error occurred otherwise it is 1.

Example:

```
res = GPIO.setSLED(3, 10, 90)
```



sets status led configuration to blinking with 1s in ON period and 9s in OFF period, assigning the return value to res.

3.6.10.

GPIO.getCBC()'

This method gets the charger status and battery voltage values in the same way as the AT#CBC command. There are no input parameters.

The return value is a Python tuple formatted in the following way:

```
(chargerStatus, batteryVoltage).
```

First element of tuple is a Python integer which is charger status:

- 0 - charger not connected
- 1 - charger connected and charging
- 2 - charger connected and charging process completed

Second element of tuple is a Python integer which is battery voltage in mV.

Example:

```
cbc = GPIO.getCBC()
```

gets charger status and battery voltage values, assigning the return value to cbc tuple.

3.7. MOD built-in module

The MOD built-in module is an interface between Python and the module miscellaneous functions. You need to use the MOD built-in module if you want to handle time functions in Python scripts.

If you want to use MOD built-in module you need to import it first:

```
import MOD
```

then you can use its methods as in the following example:

```
MOD.sleep(15)
```

this blocks the Python script execution for 1.5s.

More details about MOD built-in module methods are in the following paragraphs.



3.7.1. MOD.secCounter()

This method returns a Python long integer which is the value of seconds elapsed since 1 January 2000. This method is useful for timers generation in Python scripts. There are no input parameters.

The AT+CCLK command is used to read and to set the current date and time.

Here are some useful constants:

- 1 day = 86400 seconds
- 1 year = 31536000 or 31622400 seconds
- 30 years from 1 January 1970 to 1 January 2000 = 946684800 seconds (simply add this constant if you need seconds elapsed since 1 January 1970)

Example:

```
a = MOD.secCounter()
```

returns seconds elapsed since 1 January 2000.

3.7.2. MOD.sleep(sleeptime)

Blocks Python script execution for a given time returning the resources to the system. The input parameter *sleeptime* is a Python integer which is measured in 1/10s and used to block script execution for given value. The timeout range is (0 ÷ 32767). No return value.

Example:

```
MOD.sleep(15)
```

blocks Python script for 1.5 s.



NOTE:

the parameter *sleeptime* can assume integer values in the following range [0,32767]

3.7.3. MOD.watchdogEnable(timeout)

This method protects the system against script blocking by performing an automatic reboot of the module when the watchdog reaches a determined value. The input



parameter *timeout* is an integer, which is measured in seconds and represents the time to wait before executing the software restart. The timeout range is (1 ÷ 2147483647).

No return value.

Example:

```
MOD.watchdogEnable(50)
```

after 50sec from execution of this command module will be rebooted.

3.7.4. **MOD.watchdogReset()**

Restarts the watchdog counter that has been previously activated with the command *MOD.watchdogEnable(timeout)* preventing in this way the reboot of the module. It should be added in every part of the script that can cause a script blocking (loops, etc) and is used only when Python watchdog is enabled. No input value. No return value.

Example:

```
MOD.watchdogReset()
```

Restarts Python watchdog counter.

3.7.5. **MOD.watchdogDisable()**

Disables the Python watchdog that has been previously activated with the command *MOD.watchdogEnable(timeout)*. Python watchdog should be disabled before scripts critical lines such as *import*, since it takes a long time and then enabled again after. No input value. No return value.

Example:

```
MOD.watchdogDisable()
```

Disables Python watchdog.

3.7.6. **MOD.powerSaving(timeout)**

This new feature allows Python to put the system in power saving mode² for a certain period or until an external event³ occurs in the same way as AT command AT+CFUN=0

² ATTENTION: when the script debugging is activated, the module will not enter in power saving mode



does. The input parameter *timeout* is an integer, which is measured in seconds and represents time for which the Python script remains blocked. Python script will exit power saving mode when the determined value of timeout is reached or after unsolicited signal. If the timeout has negative value Python script will exit from power saving mode only when an external event occurs. The timeout range is [-2147483648 ÷ 2147483647].

No return value.

Example:

```
MOD.powerSaving(100)
```

Python script will exit power saving mode after 100sec or when an external event occurs.

3.7.7. MOD.powerSavingExitCause()

This command can be executed after *MOD.powerSaving(timeout)* and gives the cause of unblocking the Python script. No input parameter.

The return value is a Python integer which is 0 if Python script has exit power saving mode after an external event otherwise it is 1 if Python script has exit power saving mode after the timeout is reached.

Example:

```
MOD.powerSavingExitCause()
```

gets the cause of exiting of Python script from the power saving mode

3.7.8. MOD.encBase64(dataToCode)

This method converts the string *dataToCode* in another string of ASCII characters in base64 coding ready in lines of 76 characters.

The input parameter *dataToCode* is the Python string to be converted in base64 coding. The return value is a Python string which is the converted data in base64 coding already ready in lines of 76 characters with carriage return and newline chars according to MIME RFC 2045. If the converted data exceeds 16000 characters the return value is an empty string.

Available in version 10.00.xx3.

Example:

³ an external event e.g.: URC unsolicited message (ex. RING of incoming calls) or putting RTS high (when it goes back to low the power saving mode remains disabled)



```
dataCoded = MOD.encBase64(dataToCode)
```

converts the string `dataToCode` to another string in `base64` coding assigning the return value to `dataCoded`.

3.8. IIC built-in module

IIC built-in module⁴ is an implementation on the Python core of the IIC bus⁵ Master (No Multi-Master) using the "bit-banging" technique.

You need to use IIC built-in module if you want to create one or more IIC bus on the available GPIO pins. This IIC bus handling module is mapped on creation on two GPIO pins that will become the Serial Data and Serial Clock pins of the bus. It can be created more than one IIC bus over different pins and the pins used must not be used for other purposes.



NOTE:

Python core does not verify if the pins are already used for other purposes (SPI module or GPIO module) by other functions, it's the customer responsibility to ensure that no conflict over pins occurs.

If you want to use IIC built-in module you need to import it first:

```
import IIC
```

then you can create the new bus over the GPIO pins (for example over the pins GPIO3, GPIO4) and then use IIC built-in module methods like in the following example:

```
IICbus = IIC.new(3, 4, 0x50)
IICbus.init()
res = IICbus.readwrite('test', 10)
```

which sends 'test' and receives a string of 10 bytes from IIC bus device at address 0x50, assigning it to `res`.



NOTE:

you must provide external pull-up on SDA line since the line is working as open collector, on the other hand SCLK is driven with a complete push pull.

More details about IIC built-in module object methods are in the following paragraphs.

⁴ Note: IIC module cannot be simulated in Python Win

⁵ With the following clock frequency: 0KHz min, 20KHz typical (idle mode)



3.8.1. IIC.new(SDA_pin, SCL_pin, <ADDR>)

This command creates a new IIC bus object on the GPIO pins number. The input parameter *SDA_pin*, *SCL_pin* are Python bytes, which are the GPIO pin number where the SDA (Serial Data) and SCL (Serial Clock) lines are mapped. Optional parameter *ADDR* is the address of IIC bus device.

The return value is the Python custom IIC bus object pointer, which then shall be used to interface with the IIC bus created.

Example:

```
myIIC1 = IIC.new(3,4,0x50)
```

This creates one IIC bus over the lines SDA=GPIO3 and SCL=GPIO4 with default address 0x50.



NOTE:

available pins for the IIC bus are:

- module family GM862: GPIO1 and GPIO2 are not available
 - all other module families: all GPIO available (on previous firmware versions than 7.03.xx1 GPIO1 is not available)
-

3.8.2. IIC.init()

This command does the first pin initialisation on the IIC bus previously created. It has no input parameter. The return value is a Python integer that is -1 if an error occurred otherwise is 1.

Example:

```
status = myIIC1.init()
```



3.8.3. IIC.readwrite(string, read_len)

This command can send a string or receive a string of *read_len* bytes from from IIC bus device at address *addr*. First input parameter *string* is Python character while the second parameter *read_len* is a Python integer used in process of reading data from the IIC bus and can assume values in the range from 0 to 254. The return value is a Python string which contains received data.



NOTE:

IIC device address is 7 bits + 1 bit R/W (device address on the most significant part of byte and R/W on less significant bit of byte).



NOTE:

In a read and write application IIC.readwrite() method must be called separately once for read and once for write.

NOTE:

In an application that uses IIC.readwrite() method the parameter ADDR in IIC.new() method is mandatory.

Example of use:

```
#start of I2C example for a particular I2C device

import IIC
import MOD

I2C_SDA = 3 # GPIO used for SDA pin
I2C_SCL = 4 # GPIO used for SCL pin
I2C_ADDR = 0x50 # myIIC1 address
NUM_REGS = 8 # max # of registers

myIIC1 = IIC.new(I2C_SDA, I2C_SCL, I2C_ADDR)
status = myIIC1.init()
#MOD.sleep(5)

print ' Writing from ADDR = 0x08, DATA = "Telit" '
if myIIC1.readwrite('\x08'+ 'Telit',0) == -1:
    print 'Error acknowledged'
#MOD.sleep(5)

ret = myIIC1.readwrite('\x08', 14) # Random read
print ' RANDOM READ FROM ADDR = 0x08, 14 bytes: %s' % ret
#MOD.sleep(5)
```



```
print ' Writing DATA= "hello!" from ADDR = 0x00'
myIIC1.readwrite('\x00'+ 'hello!', 0)
#MOD.sleep(5)

print ' SETTING CURRENT ADDRESS = 0x00'
if myIIC1.readwrite('\x00',0) == -1:
    print 'Error acknowledged'
#MOD.sleep(5)

ret = myIIC1.readwrite('', 22) # Current address read
print ' CURRENT ADDR READ = 0x00, 22 bytes: %s' % ret
MOD.sleep(5)

ret = myIIC1.readwrite('\x00', 254) # Current address read
print ' read 254 bytes with readwrite: %s' % ret
```

3.8.4. IIC.sendbyte(byte)



NOTE:

We suggest to use the new readwrite (2.8.3) method to send bytes or strings.

Sends a byte to the IIC bus previously created. The input parameter *byte* is a Python byte which is the byte to be sent to the IIC bus. The start and stop condition on the bus are added by the function.

The return value is a Python integer which is -1 if an error occurred otherwise is 1 the byte has been acknowledged by the slave.

Example:

Supposing to set:

```
bus1 = IIC.new(3,4)
bus2 = IIC.new(5,6)
a = bus1.init()
```

then:

```
a = bus1.sendbyte(123)
```

sends byte 123 to the IIC bus , assigning the return result value to a.

3.8.5. IIC.send(string)



NOTE:

We suggest to use the new readwrite (2.8.3) method to send bytes or strings.



Sends a string to the IIC bus previously created. The input parameter *string* is a Python string which is the string to send to the IIC bus.

The return value is a Python integer which is -1 if an error occurred otherwise is 1 if all bytes of the string have been acknowledged by the slave.

Example:

```
a = bus1.send('test')
```

sends string 'test' to the IIC bus , assigning the return result value to a.

3.8.6. IIC.dev_read(addr, len)



NOTE:

We suggest to use the new readwrite (2.8.3) method to send bytes or strings.

Receives a string of *len* bytes from IIC bus device at address *addr*.

The return value is a Python string which is containing data received.

Example:

```
a = bus1.dev_read(114,10)
```

receives a string of 10 bytes from IIC bus device at address 114, assigning it to a.

3.8.7. IIC.dev_write(addr, string)



NOTE:

We suggest to use the new readwrite (2.8.3) method to send bytes or strings.

Sends a string to the IIC bus device at address *addr*.

The return value is a Python integer which is 1 if data is acknowledged correctly, -1 otherwise.

Example:

```
a = bus1.dev_write(114, '123456789')
```

sends the string '123456789' to the IIC bus device at address 114, assigning the result to a.



3.8.8. IIC.dev_gen_read(addr, start, len)



NOTE:

We suggest to use the new `readwrite` (2.8.3) method to send bytes or strings.

Receives a string of *len* bytes from IIC bus device whose address is *addr*, starting from address *start*. The return value is a Python string which is containing data received.

Example:

```
a = bus1.dev_gen_read(114,122, 10)
```

receives a string of 10 bytes from IIC bus device at address 114, starting from address 122 assigning it to a.

3.8.9. IIC.dev_gen_write(addr, start, string)



NOTE:

We suggest to use the new `readwrite` (2.8.3) method to send bytes or strings.

Sends a string to the IIC bus device whose address is *addr*, starting from address *start*. The return value is a Python string which is 1 if data is acknowledged correctly, -1 otherwise.

Example:

```
a = bus1.dev_gen_write(114, 112, '123456789')
```

sends the string '123456789' to the IIC bus device at address 114, starting from address 112, assigning the result to a.



3.9. SPI built-in module

SPI built-in module⁶ is an implementation on the Python core of the SPI bus⁷ Master using the "bit-banging" technique. You need to use SPI built-in module if you want to create one or more SPI bus on the available GPIO pins.

This SPI bus handling module is mapped on creation on three or more GPIO pins that will become the Serial Data In/Out and Serial Clock pins of the bus, plus a number of optional chip select pins up to 8. It can be created more than one SPI bus over different pins and these pins must not be used for other purposes.



NOTE:

Python core does not verify if the pins are already used for other purposes (IIC module or GPIO module) by other functions, it's the customer responsibility to ensure that no conflict over pins occurs.

If you want to use SPI built-in module you need to import it first:

```
import SPI
```

the functions to use are: create your SPI object (new), initialize (init) and transfer data (readwrite) like in the example:

```
mySPIobject = SPI.new(3, 4 ,5, 6)
mySPIobject.init(0, 0, 0, 0)
d = mySPIobject.readwrite('test', 4)
```

sends 'test' and receives byte from the SPI bus device.

More details about SPI built-in module object methods are in the following paragraphs.

⁶ Note: SPI module cannot be simulated in Python Win

⁷ With the following clock frequency: 0KHz min, 20KHz typical (idle mode)



3.9.1. SPI.new(SCLK_pin, MOSI_pin, MISO_pin, <SS0>, <SS1>,...<SS7>)

This command creates a new SPI bus object on the corresponding GPIO pins. The input parameter SCLK_pin, MOSI_pin and MISO_pin are Python bytes that represent the GPIO pin number where the SCLK (Serial CLock), MOSI (Master Output Slave Input), MISO (Master Input Slave Output) lines are mapped.

The input parameter SS_i_line is a mandatory Python byte if the SPI device needs to be selected by Slave Select line: it is the GPIO pin number where the SS_i (ith Slave Select) line is mapped. Up to 8 Slave Select lines can be defined.

The SS_pin is optional because not all SPI devices have a Slave Select line, otherwise named Chip Select (CS) line.

The return value is the Python custom SPI object pointer that will be used further to interface with this specific SPI object created.

Example:

```
mySPIobject = SPI.new(6, 7, 8, 9, 10)
```

Creates an SPI object “mySPIobject” where SCLK=GPIO6, MOSI=GPIO7, MISO=GPIO8 and SS0=GPIO9, SS1=GPIO10



NOTE:

available pins for the SPI bus are:

- module family GM862: GPIO1 and GPIO2 are not available
 - all other module families: GPIO1 is not available
-



3.9.2. SPI.init (CPOL, CPHA, <SSPOL>, <SS>)

This command performs the initialization on the SPI bus previously created, and can be reused as many time as necessary if some of its parameters need changes during work. The first input parameter *CPOL* represents clock polarity and is controlled in the following way:

- *CPOL* = 0 - clock polarity low
- *CPOL* = 1 - clock polarity high

The second input parameter *CPHA* represents clock phase transmission and is controlled in the following way:

- *CPHA* = 0 - data bit is clocked/latched on the first edge of the SCLK.
- *CPHA* = 1 - data bit is clocked/latched on the second edge of the SCLK.

The combinations of polarity and phases are often referred to as SPI modes.

Third parameter *SSPOL* is optional and represents the Slave Select Polarity and can assume the following values:

- *SSPOL* = 0 - polarity low (default)
- *SSPOL* = 1 - polarity high

Fourth parameter *SS* is optional and represents the Default Slave Select line number to use among the already defined slave select (SS) lines for this SPI object and then it can assume values from 0 to 7.

- *SS* = unused - means that if not SS settled in *readwrite()* parameter’s function, no SS will be moved.
- *SS* = 0...7 – Defined the default SS line to move if not SS settled in *readwrite()* parameter’s function.

The return value is a Python integer, which is -1 if an error occurred, otherwise is 1.

Example:

```
status = mySPIobject.init(0, 0, 0)
```

In this initialization no SS line is defined as default, and no SS line will be moved if not set in *readwrite* function.

```
status = mySPIobject.init(0, 0, 0, 1)
```



In this initialization the SS=1 refers to the use of SS1, already defined in SPI.new(6, 7, 8, 9, 10) as GPIO10.

```
status = mySPIObject.init(0, 0, 0, 0)
```

In this initialization the SS=0 refers to the use of SS0, already defined in SPI.new(6, 7, 8, 9, 10) as GPIO9.

3.9.3. SPI.readwrite(string, <read_len>, <SS>)

This command sends string and receives *read_len* bytes at the same time from SPI bus device at Slave Select line number *SS*.

The first input parameter *string* is a Python string while the second optional⁸ parameter *read_len* is a Python integer used only for reading data and can assume values in the range from 0 to 254.

The read_len value includes also the bytes transmitted.

For example if the string to be sent has 6 bytes then:

- if read_len = 3 spi receive and save only the first 3 bytes, the others 3 bytes received during transmission of the other 3 bytes left are lost.
- if read_len = 10 the spi receive the first 6 bytes together with the sent bytes and then send 0x00 another 4 times to complete the 10 bytes to receive.

The third optional input parameter *SS*, if defined, selects which of *SS* line number defined in *SPI.new* will be used and, if not defined, the default Slave Select line number in *SPI.init*, if any, will be used.

The return value is a Python string that contains (*read_len bytes*) of sent and/or received data, in case an error occurs return value will be -1 or NULL if is memory error.

Example:

```
myString = mySPIObject.readwrite('hello', 10)
```

send the string "hello" and receives a string of 10 bytes from the SPI device, assigning it to *myString*

Example of writing and reading of a memory in a particular SPI device (addressable by a Slave Select pin)

⁸ In case of read operation this parameter is mandatory



Easy Script in Python

80000ST10020a Rev.13 – 2010-12-03

```

#start of SPI example
import SPI
import MOD
import MDM
import GPIO

CMD_WRITE = '\x02'          #this value is not the value for any
                             #SPI device, but for tested one only!

CMD_READ = '\x03'           #this value is not the value for any
                             #SPI device, but for tested one only!

CMD_RESET = '\xC0'

REG_ADDR_X = '\x0E'         #this value is not the value for any
                             #SPI device, but for tested one only!

REG_ADDR_Y = '\x0F'         #this value is not the value for any
                             #SPI device, but for tested one only!

TWO_READ_ACCESS = '\x00\x00' # string of the length equal to
                              #the number of bytes to receive

MySPI1 = SPI.new (3,10,8,6)  # (SCLK, MOSI, MISO, SS)
MySPI1.init (0,0,0,0)       # (CPOL, CPHA, SSPOL, SS)

# Power Up, Reset and Clock ON routine for the SPI
# device can also be implemented from outside

MySPI1.readwrite (CMD_WRITE + REG_ADDR_Y + '\xAC')
                           # write 0xAC in REG_ADDR_Y

# values of myString [0] and myString [1] correspond to
# the status output while writing
myString = MySPI1.readwrite (CMD_READ + REG_ADDR_X, 4)
print "DATA VALUE AT ADDR_X and _Y =",hex(ord(myString[2]))+' and \
'+ hex(ord(myString[3]))

# does the same as previous: this is to maintain the backward
# compatibility with the past version of the readwrite method
myString = MySPI1.readwrite(CMD_READ + REG_ADDR_X + TWO_READ_ACCESS,4)

# read first byte (cmd) plus 128 bytes starting from the last position
ret = MySPI1.readwrite (CMD_READ, 129)

i = 0
print "STATUS =",hex(ord(ret[i]))
while (i < 128):
    print "REGISTER[" ,hex(i), "]" ,hex(ord(ret[i + 1]))
    i = i + 1

#end of SPI example

```



3.9.4. SPI.sendbyte(byte, <SS_number>)



NOTE:

We suggest to use the new *readwrite* (3.9.3) method to send bytes or strings.

Sends a byte to the SPI bus previously created addressed for the Slave number *SS_number* whose Slave Select signal is activated. The input parameter *byte* is a Python byte which is the byte to be sent to the SPI bus. Optional parameter *SS_number* is a Python byte representing the Slave number to be activated; if not present no slave line is activated.

The return value is a Python integer which is -1 if an error occurred otherwise is 1 the byte has been sent.

Example:

```
a = bus3.sendbyte(123)
```

sends byte 123 to the SPI bus , assigning the return result value to a.

```
b=bus4.sendbyte(111,1)
```

sends byte 111 to the SPI bus activating the Slave Select line of the SS1 device (in our example GPIO10).

3.9.5. SPI.readbyte(<SS_number>)



NOTE:

We suggest to use the new *readwrite* (3.9.3) method to send bytes or strings.

Receives a byte from the SPI bus device at Slave Select number *SS_number*. Input optional parameter *SS_number* is a Python byte representing the Slave number to be activated; if not present no slave line is activated.

The return value is a byte (integer) received from the SPI bus device if no data is received the return value will be zero.

Example:

```
a = bus3.readbyte()
```

receives a byte from the SPI bus , assigning the return result value to a.



```
b = bus4.readbyte(1)
```

receives a byte from the SPI bus device on SS1 line, assigning the return result value to b.

3.9.6. SPI.send(string, <SS_number>)



NOTE:

We suggest to use the new *readwrite* (3.9.3) method to send bytes or strings.

Sends a string to the SPI bus previously created. The input parameter *string* is a Python string which is the string to send to the SPI bus. Optional parameter *SS_number* is a Python byte representing the Slave number to be activated; if not present no slave line is activated.

The return value is a Python integer which is -1 if an error occurred otherwise is 1 if all bytes of the string have been sent.

Example:

```
a = bus3.send('test')
```

sends string 'test' to the SPI bus , assigning the return result value to a.

3.9.7. SPI.read(len, <SS_number>)



NOTE:

We suggest to use the new *readwrite* (3.9.3) method to send bytes or strings.

Receives a string of *len* bytes from SPI bus device at Slave Select number *SS_number*. Input optional parameter *SS_number* is a Python byte representing the Slave number to be activated; if not present no slave line is activated.

The return value is a Python string that contains received data.

Example:

```
a = bus4.read(10,0)
```

receives a string of 10 bytes from SPI bus device on SS0 line, assigning it to a.



3.10. GPS⁹ built-in module

GPS built-in module is the interface between Python and module internal GPS controller. It is used in order to handle GPS controller without dedicated AT commands through MDM built-in module.

If you want to use GPS built-in module you need to import it first:

```
import GPS
```

After this you can start using GPS built-in module methods like in the following example:

```
position = GPS.getActualPosition()
```

gets a string with position information formatted in the same way as AT\$GPSACP response.

More details about GPS built-in module methods can be found in the following paragraphs.

3.10.1. GPS. powerOnOff(newStatus)

This method powers ON/OFF GPS controller in the same way as AT command: AT\$GPSP.

The input parameter *newStatus* is a Python integer and can have the following values:

- 0 to power OFF GPS controller
- 1 to power ON GPS controller.

There is no return value.

Example:

```
GPS.powerOnOff(0)
```

GPS controller is powered OFF.

⁹ Available only for the following modules: GM862-GPS, GE863-GPS.



3.10.2. GPS.getPowerOnOff()

This method gets GPS controller current power ON/OFF status. It has no input parameter.

The return value is a Python integer which is 0 if GPS controller is powered off or 1 if GPS controller is powered on.

Example:

```
status = GPS.getPowerOnOff()
```

gets GPS controller current power ON/OFF status, assigning the return value to status.

3.10.3. GPS.resetMode(mode)

This method resets GPS controller in the same way as AT command: AT\$GPSR. The input parameter *mode* is a Python integer and can have the following values:

0 for Hardware reset

1 for Coldstart (No Almanac, No Ephemeris);

2 for Warmstart (No Ephemeris);

3 for Hotstart (with stored Almanac and Ephemeris)

The return value is a Python integer which is -1 if an error occurred otherwise is 1.

Example:

```
res = GPS.resetMode(1)
```

executes a cold restart of GPS controller, assigning the return value to res.

3.10.4. GPS.getAntennaVoltage()

This method gets GPS antenna supply voltage in the same way as AT command: AT\$GPSAV.

It has no input parameter.

The return value is a Python integer which represents antenna supply voltage in mV.

Example:

```
mV = GPS.getAntennaVoltage()
```

gets GPS antenna supply voltage, assigning the return value to mV.



3.10.5. GPS.getAntennaCurrent()

This method gets GPS antenna current consumption in the same way as AT command: AT\$GPSAI.

It has no input parameter.

The return value is a Python integer which represents antenna current consumption in mA.

Example:

```
mA = GPS.getAntennaCurrent()
```

gets GPS antenna current consumption, assigning the return value to mA.

3.10.6. GPS.getActualPosition()

This method gets GPS last position information stored in the same way as with AT command: AT\$GPSACP. It has no input parameter.

The return value is a Python string which is the last position information formatted in the same way as for AT\$GPSACP command response.

Example:

```
lastPosition = GPS.getActualPosition()
```

gets GPS last position information, assigning the return value to lastPosition.

3.10.7. GPS.powerSavingMode(mode, pushToFixPeriod)

This method sets GPS controller power saving mode in the same way as AT command AT\$GPSPS.

The first input parameter *mode* is a Python integer and can have the following values:

- 0 for Power Saving disabled – Continuous Power (default);
- 1 for Trickle Power activated;
- 2 for Push To Fix Mode enabled.

The second input parameter *pushToFixPeriod* is a Python integer which is the value of push to fix period in seconds used when *mode=2*. If *mode=0* or *mode=1* this parameter has no meaning and can be set to any value.

The return value is a Python integer which is -1 if an error occurred otherwise is 1.

Example:

```
res = GPS.powerSavingMode(2, 15)
```



sets GPS controller in power saving mode 2 with push to fix period of 15 seconds, assigning the return value to res.

3.10.8. GPS.powerSavingWakeUp()

This command wakes up GPS controller while in power saving mode in the same way as AT command AT\$GPSWK.

It has no input parameter.

The return value is a Python integer which is -1 if an error occurred otherwise is 1.

Example:

```
res = GPS.powerSavingWakeUp()
```

wakes up GPS controller while in power saving, assigning the return value to res.

3.10.9. GPS.getLastGGA()

This command gets GPS last GGA NMEA sentence stored. It has no input parameter.

The return value is a Python string which is the last GGA NMEA sentence formatted according to NMEA specification.

Example:

```
gga = GPS.getLastGGA()
```

gets last GGA NMEA sentence, assigning the return value to gga.

3.10.10. GPS.getLastGLL()

This command gets GPS last GLL NMEA sentence stored. It has no input parameter.

The return value is a Python string which is the last GLL NMEA sentence formatted according to NMEA specification.

Example:

```
gll = GPS.getLastGLL()
```

gets last GLL NMEA sentence, assigning the return value to gll.



3.10.11. GPS.getLastGSA()

This command gets GPS last GSA NMEA sentence stored. It has no input parameter. The return value is a Python string which is the last GSA NMEA sentence formatted according to NMEA specification.

Example:

```
gsa = GPS.getLastGSA()
```

gets last GSA NMEA sentence, assigning the return value to gsa.

3.10.12. GPS.getLastGSV()

This command gets GPS last GSV NMEA sentence stored. It has no input parameter. The return value is a Python string which is the concatenation of the last GSV NMEA sentences formatted according to NMEA specification.

Example:

```
gsv = GPS.getLastGSV()
```

gets last GSV NMEA sentence, assigning the return value to gsv.

3.10.13. GPS.getLastRMC()

This command gets GPS last RMC NMEA sentence stored. It has no input parameter. The return value is a Python string which is the last RMC NMEA sentence formatted according to NMEA specification.

Example:

```
rms = GPS.getLastRMC()
```

gets last RMC NMEA sentence, assigning the return value to rmc.

3.10.14. GPS.getLastVTG()

This command gets GPS last VTG NMEA sentence stored. It has no input parameter. The return value is a Python string which is the last VTG NMEA sentence formatted according to NMEA specification.



Example:

```
vtg = GPS.getLastVTG()
```

gets last VTG NMEA sentence, assigning the return value to vtg.

3.10.15. GPS.getPosition()

This command gets GPS last position stored in numeric format. It has no input parameter.

The return value is a Python tuple formatted in the following way

```
(latitude, latNorS, longitude, lonEorW)
```

where:

- The first element of tuple is a Python integer which is latitude in (degrees * 10000000), that is in degrees with 10000000 scale factor.
- The second element of tuple in a Python string which is 'N' for north or 'S' for south.
- The third element of tuple is a Python integer which is longitude in (degrees * 10000000), that is in degrees with 10000000 scale factor.
- Fourth element of tuple in a Python string which is 'E' for east or 'W' for west.

If GPS controller has no position information the following tuple is returned:
(0, "", 0, "").

Example:

```
pos = GPS.getPosition()
```

gets last position stored, assigning the return value to pos.



4. Python Script Operations

4.1. Executing a Python script

The steps required to have a script running by the Python engine of the module are:

- write the Python script;
- compile the Python script (optional);
- download the (compiled) Python script into the module NVM;
- enable the Python script;
- execute the Python script.



4.1.1. Compiling the Python script

Telit has created a new version of PythonWin 4.1 in order to reduce the compilation time of Python scripts on module (during the development phase) and to improve other Python features as well:

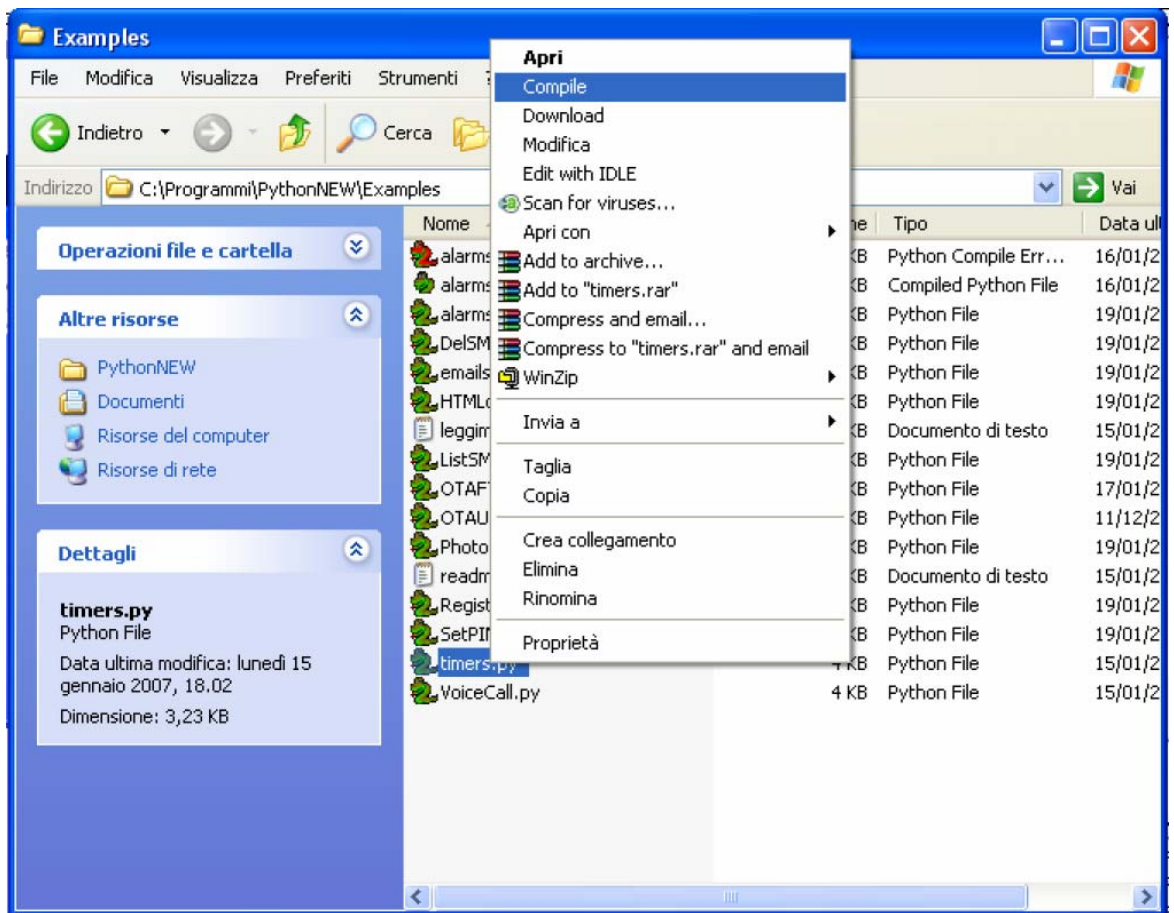

A new "compile" option has been added to the contextual menu accessible by right clicking on the Python script. This option compiles the file and saves it on the same directory with a *.pyo extension. Compilation results and further errors will appear in the active window.

Compilation in PythonWin can also be performed with the shortcut key F6.

In case of an error during the compilation process, a new file (with a red Python icon) and associated error log are created with a *.pye extension. The DOS window will



remain open in case of compilation errors, otherwise it's closed at the end of the compilation.

When the Python script is compiled in PythonWin, further errors will be reported in the Interactive Window, while in the Python script window they'll be indicated by the cursor.

A "download"^[1] option has been added to the contextual menu of compiled and simple text Python files, which implement a reliable download of Python scripts on the module.

Shortcut key F3 in PythonWin will start a quick search of selected text in the active file.

4.1.2. Write Python script

A Python script is a simple text file, it can be written with any text editor but for your convenience a complete Integrated Development Environment (IDE) is included in a software package that Telit provides called *Telit Python Package*.

Remembering the supported features described in 2.6, it is simple to write the script and test it directly from the IDE.

The following is the "Hello Word" short Python script that sends the simplest AT command to the AT command parser, waits for response and then ends.

```
import MDM
print 'Hello World!'
result = MDM.send('AT\r', 0)
print result
c = MDM.receive(10)
print c
```

4.1.3. Download Python script

Command: AT#WSCRIPT="`< script_name >`",`< size >`,`< know-how >`

- `< script_name >`: file name
- `< size >`: file size (number of bytes)
- `< know-how >`: know how protection, 1 = on, 0 = off (default)

The script, the compiled script, any text or binary file, can be downloaded on the module using the #WSCRIPT command. In order to guarantee your company know-how, you have the option to hide the script text so that the #RSCRIPT command does not return the text of the script and keeps it "confidential", you can see the name of the script only using the #LSCRIPT command.

^[1] In order to avoid unwanted compilation on the module we advise you to download only Python files with .pyo as extension.



Easy Script in Python

80000ST10020a Rev.13 – 2010-12-03

Remember that if you chose to hide the script text, it is your responsibility to keep the information about what is executed on the module; for example, by naming the script based on the application and script version.

In order to download the (compiled) script, you have to choose a name for your script on the module, taking care of the following:

- the extension for scripts is .py¹⁰;
- the maximum length allowed is 16 characters;
- script names are case sensitive (“Script.py” and “script.py” are two different scripts).

Then you have to find out the exact size of the script in bytes (or pre-compiled script, or generic text or binary file). For example, right clicking on the file and selecting “size” in “properties” (attention: this is different from selecting “size on the disc”).

The script in *Hyper Terminal* is downloaded regardless the previous serial settings at: 115200 baud 8-N-1 and with hardware flow control.

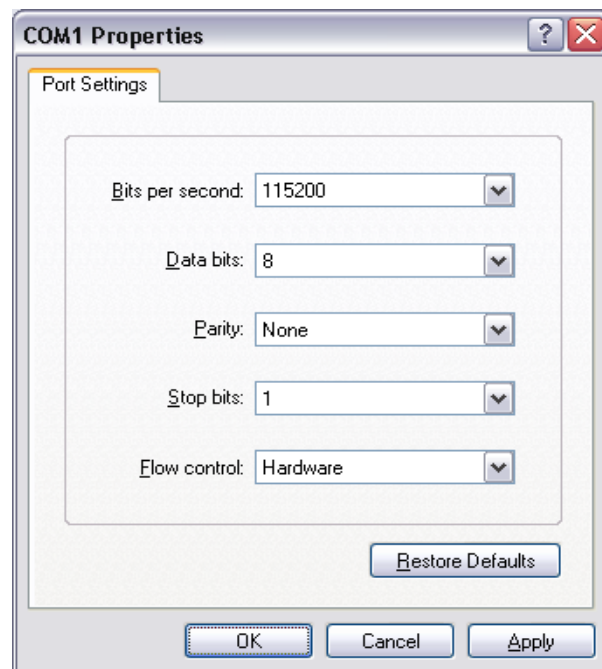

¹⁰ Pre-compiled files will have a .pyo extension, though any or no extension is permitted for generic text or binary files.



For example:

```
AT#WSCRIPT="a.py",110
```

wait for the prompt

```
>>>
```

and use "Send Text file" with ASCII Setup: "Send line ends with line feeds" and "Append line feeds to incoming line ends" in *HyperTerminal* "Properties" enabled.
Wait for the result: OK or ERROR.



TIP:

In order to see all files and select the right one in the "Send text file" window, select "All files (*.*)" in the "Files of type" line.

TIP:

If it gives ERROR, then check the script name (remember that it is case sensitive) or the file size.



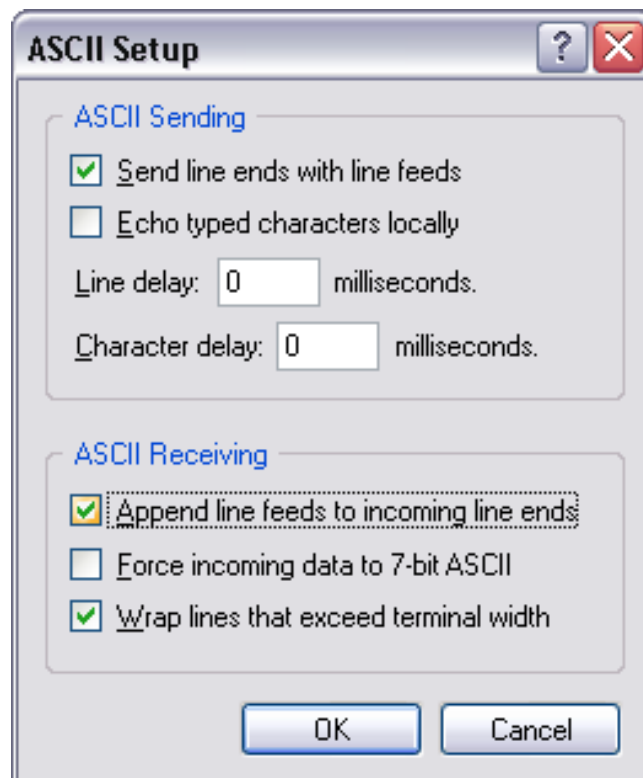
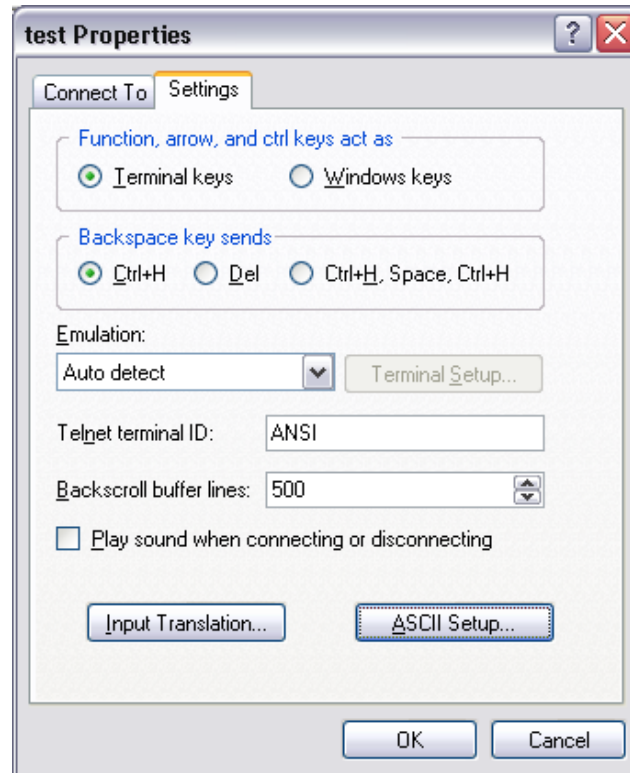

Another way to download using *HyperTerminal* and when *PythonWin* is installed, is to disconnect and, when the prompt appears, to right click on the file and select “download”. Reconnect after the download completes.

4.1.4. Enable Python script

Command:

```
AT#ESCRIP="< script_name >"
```

```
AT#ESCRIP?
```

< script_name >: file name

Select the Python script which will be executed (the enabled script .py or .pyo) from the next start-up and in every future start-up using the AT#ESCRIP command. In case the Python script consists of more than one file only the main file should be executed. First choose the script you want to enable between the ones you’ve downloaded:

AT#LSCRIP? can help you checking the names of the scripts;

AT#ESCRIP? can help you check the name of the script that is enabled at the moment



NOTE:

There is no error return value for non existing script name in the module memory typed in command AT#ESCRIP. For this reason it’s recommended to double check the name of the script that you want to execute. On the other hand this characteristic permits additional possibilities: like enabling the Python script before downloading it on the module or non having to enable the same script name every time the script has been changed, deleted and replaced with another script but with the same name. Note also that the file extension must be .py.

For example:

```
AT#ESCRIP="a.py"
```

Wait for enable result: OK.



4.1.5. Execute Python script

The Python script you have downloaded to module and enabled is executed at every module power on if the DTR line is sensed LOW (2.8V at the module DTR pin - RS232 signals are inverted -) at start-up, (in this case no AT command interface is connected to the modem port) and if the script name you enabled matches with one of the script names of the scripts you downloaded.¹¹

In order to gain again the AT command interface on the modem physical port (for example to update locally a new script) the module shall be powered on with the DTR line HIGH (0V at the module DTR pin) so that the script is not executed and the Python engine is stopped.



NOTE:

See AT#STATMODESCR and AT#EXECSCR commands description for further Python script execution modes.

The real execution of the Python script is delayed from the power on due to the time needed by Python to parse the not compiled script. The longer is the script, the longer is this delay. The real execution of compiled Python scripts (.pyo) is faster just opening and reading the file from NVM.



TIP:

It is strongly suggested to compile all Python scripts on the PC and download only .pyo files to the module to speed up the scripts execution.

4.1.6. Reading Python script

Command: AT#RSCRIPT="`< script_name >`"

`< script_name >`: file name

With the following command AT#RSCRIPT you can read a saved script text, a compiled script, a generic text or binary file. The file read can be saved using "Capture Text" in *HyperTerminal*. Port settings should be baud rate 115200bps and hardware flow control.

¹¹ The Python script will be executed when the module is powered ON and if the serial cable has previously been disconnected.



If know-how protection is activated than AT#RSCRIPT will return only OK: no Python script source code will be returned. In this way no one will be able to read your Python script from the module serial port.

The Python script will be still in the Python script list and it will be still possible to delete it and to overwrite it.

Example:

AT#RSCRIPT="a.py"

returns Python script source code a.py

4.1.7. List saved Python scripts

Command: AT#LSCRIPT

This command shows the list of the file names currently saved and the number of free bytes in memory.

4.1.8. Deleting Python script

Command: AT#DSCRIPT="<< script_name >"

< script_name >: file name

The Python script, compiled script, generic text or binary file can be deleted from the module memory using the #DSCRIPT command.

For example:

AT#DSCRIPT="a.py"

Wait for result: OK.

4.1.9. Restart Python script

Command: AT#REBOOT

This is an execution command that causes the restart of the module and execution of the active script on the start-up.



4.2. Run AT Interface and Python at the same time

With new start mode for Python it is possible to use the standard AT command interface on ASC0 and run a Python script at the same time. This behavior can be obtained with the following AT command:

```
AT#STARTMODESCR=2
```



NOTE:

This command will be active only after a reboot or switching off and then on the device.

When this command is set, note that the following differences with the standard use of AT interface will appear:

- the AT command interface is available on ASC0 and is connected to third AT instance parser. Note that parameters saved in profiles can be different between different AT instance parsers, so in this case only setting from the third AT instance parser will be applied.¹²
- the AT command interface is available on ASC0 and is connected to third AT instance parser even while the script is not enabled (AT#ESCRPT) and is not running.
- the AT command interface is available on ASC0 and continues to be connected to third AT instance parser also in case Python script exits, for an error or ends normally.
- the AT command interface will not be available on ASC0 if the Python script imports module SER.
- For backward compatibility MDM interface must stay connected to first AT instance parser and MDM2 interface must stay connected to second AT instance parser.
- If there is an enabled Python script and the module is powered-on the Python script will start running, the only way to interrupt its execution is to disable it by sending AT#ESCRPT and reboot the Telit module. Another possibility is to change script startmode with AT#STARTMODESCR¹³ command by setting parameter values to 0 or 1 while the Python script is running and rebooting the Telit module afterwards.
- This mode is not compatible with the use of CMUX protocol or the setting AT#CMUXSCR=1.

¹² Normally, the AT command interface on ASC0 is connected to the first AT instance parser (in case we're using the serial port with or without CMUX and there is no Python script running) while in case of AT#STARTMODESCR=2, CMUX is activated and the third CMUX port will be used for AT command interface (which means that the settings from the third AT instance parser will be applied).

¹³ For further information on this AT command and parameter settings please consult the AT Commands Reference Guide



4.3. Debug Python script

The debug of the active Python script can be done both on the emulated environment of the [Telit Python Package](#) (refer to its documentation) or directly on the target with the second serial port pin EMMI TX (actually a not translated RS232 serial port as the RXD pin).

Connect to the module serial port EMMI TX at 115200 8-N-1 with hardware flow control active.

Now you can see all Python outputs to stdout and stderr:

- Python information messages (for example the version);
- Python error information;
- Results of all Python “print” statements.

The [Telit GM862-GPS](#) and [GE863-GPS](#) have the second serial port pin EMMI TX used for continuous direct output of GPS NMEA sentences that’s why there is another procedure to follow for debugging of the Telit GPS modules. There are two ways to perform direct debugging: activate SSC port or use CMUX.

4.3.1. Debug Python script on GPS modules using SSC bus

SSC (Serial Synchronous Controller) port can be configured to be compatible to the SPI Interface, available via 4 GPIO pins. In this case the Python debug data will be read from the USB port placed on the EVK2.



NOTE:

for the direct debug of GPS modules a software version starting from 7.02.001 is needed



4.3.1.1. Installation of the drivers

Before starting the process of debug the drivers should be installed in the following way:

- Download the FTDI drivers and the installation guide in order to use the USB port placed on the EVK2 (<http://www.ftdichip.com/Drivers/D2XX.htm>)
- Save the drivers (unzipped) on the PC
- After connecting USB cable with PC and USB port placed on the EVK2 (that has been powered on): the installation procedure should start, according to the installation guide instructions
- When the installation is concluded you will have four new COM ports (see Control Panel – System – Hardware – Device Manager) and one not visible SSC port

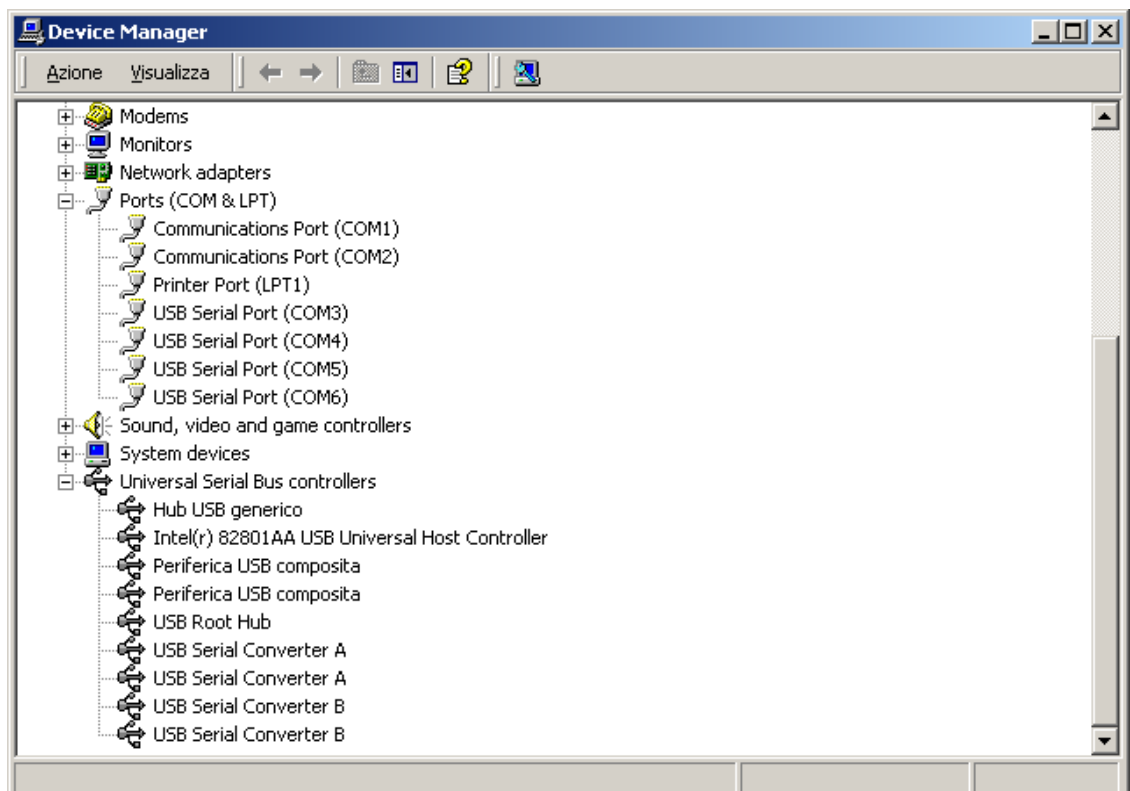

- close any application controlling the serial ports and install the *Python Debug* application (please contact our technical support to get *Python Debug* application)





NOTE:

if an error messages appears during the installation, it will be necessary to close any application controlling the serial ports

- the following box should appear when you run the *Pythondebug.exe* for the first time:

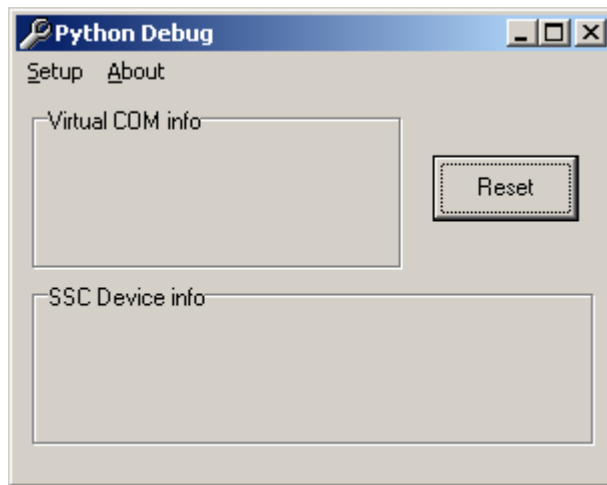

- Select the Setup option.
- Then select a Virtual COM, different from the other COM ports preferably ("COM8" in the figure), and associate to it the first SSC device that appearing in the list ("Data Module EVK2A" in the figure),

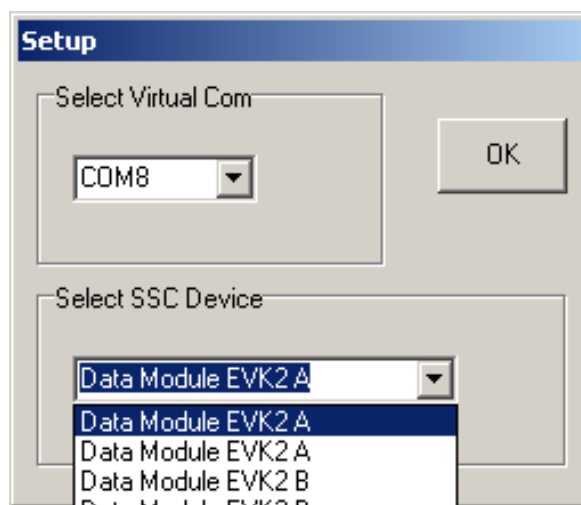

- the following figure should appear:

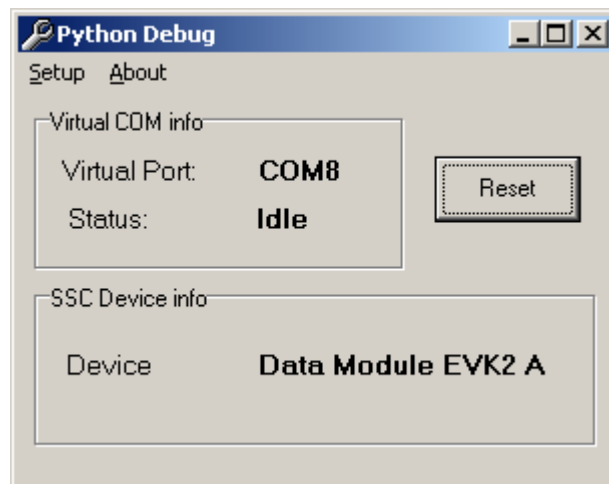

NOTE:

If the PC uses the EVK2 RS232 upper port (ASC0) to send AT commands, remember to put all jumpers to set RS232 mode. This will not affect reading of Python debug data from the USB port

4.3.1.2. Debugging process

After the successful installation of the drivers process of direct debugging of the Telit GPS modules can start. The steps are the following:

- Switch on the module and activate the SSC output with the following AT command: AT#SSCTRACE=1
- Download and enable your Python script, then power OFF the module.
- to be sure that DTR input to the module is HIGH disconnect the RS232 cable from the module side (i.e. RS232 DTR on the modem serial port is LOW);
- check if you have the USB cable connected between the USB port of the PC and the USB port placed on the EVK2



Easy Script in Python
80000ST10020a Rev.13 – 2010-12-03

- every time before you power ON the module you have to click on the *Reset* button in the *Python Debug* application (necessary to reactivate the association between the virtual Com port and the SSC device)
- Run a terminal emulator application (e.g. *Hyper Terminal*) to trace the activity of the Python script, with the following setting:

connected COM	virtual Port set in <i>Python Debug</i> (COM8 in the example)
Bit rate	115 200
Data bits	8
Parity	No parity
Stop bit	1
Flow control	Hardware

- Power ON the module and you should see the script starting and the debug info appearing on the terminal emulator window.
- If the debug strings do not appear on the screen: power OFF the module, check again if USB cable is correctly connected, reset the *Python Debug* application, than power ON the module and run the terminal emulator application with the same settings as before.

4.3.2. Debug Python script on GPS modules using CMUX

CMUX (Converter-Multiplexer) is a multiplexing protocol implemented in the Telit module that can be used to send data, SMS, fax, TCP data. The Multiplexer mode enables one serial interface to transmit data to four different customer applications form which one is dedicated to Python debug. This is achieved by providing four virtual channels using a Multiplexer (Mux).

With activating of the CMUX feature debugging data can be received on the serial ASC0 port mounted on EVK2.



NOTE:

for the direct debug of GPS modules a software version starting from 7.02.X01 is needed.



4.3.2.1. Installation

- Install the *Telit Serial Port Mux* ver 1.08-B001¹⁴ application on your PC. A box similar to this will appear at the end of installation:

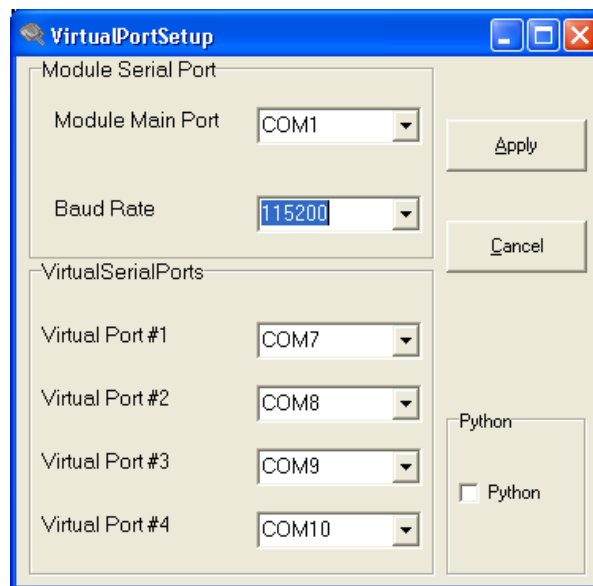

- Select the baud rate and then click on the Apply button

¹⁴ please contact our technical assistance to get the latest version



4.3.2.2. Debugging process



NOTE:

If the PC uses the EVK2 RS232 upper port (ASC0) to send AT commands, remember to put all jumpers to set RS232 mode.

Otherwise, connect the serial port for AT commands (ASC0) and a PC RS232 COM port with a RS232 serial cable. The CMUX needs all the UART connections except RING and DCD to implement flow control. A workaround does exist to avoid the usage of the full HW flow control; it consists in connecting TX, RX, and CTS. From the PC side, loop together DTR and DSR line as described in the following picture:

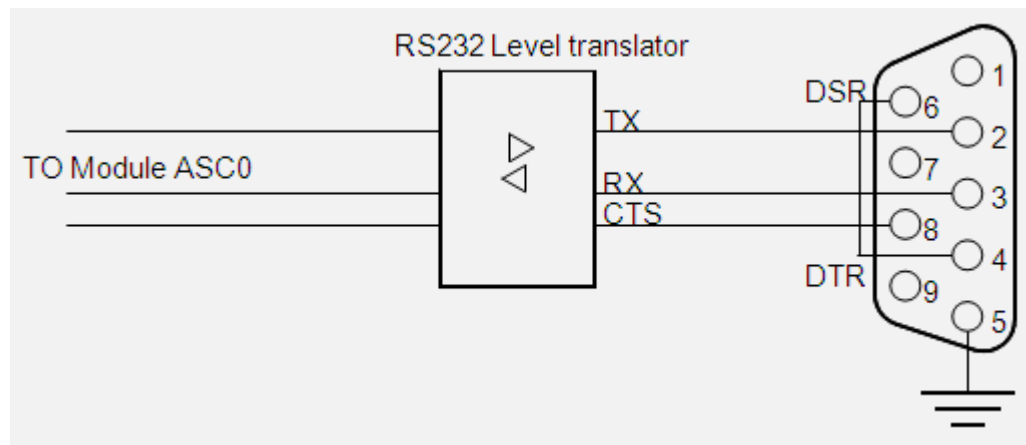

- Switch ON the module and with a terminal emulator (e.g. *Hyper Terminal*) and send the following commands to the module:

AT#SSCTRACE=0 disabled SSC output
AT#CMUXSCR=1, <bitrate> activated the CMUX feature on the module;
 put the desired bit rate (e.g. 115200)

AT#STARTMODESCR=1, 10 module waits for minimum 10 seconds (recommended value; can be changed) and if there is no AT commands sent in this period (except AT<Enter>) start the enabled Python script, regardless of the DTR status (low or high).



Easy Script in Python
80000ST10020a Rev.13 – 2010-12-03

- Download and enable¹⁵ your Python script, then power OFF the module.
- Close any application controlling the serial ports (e.g. *Hyper Terminal*)
- Run the *Telit Serial Port Mux* ; a figure similar to the one below will appear:

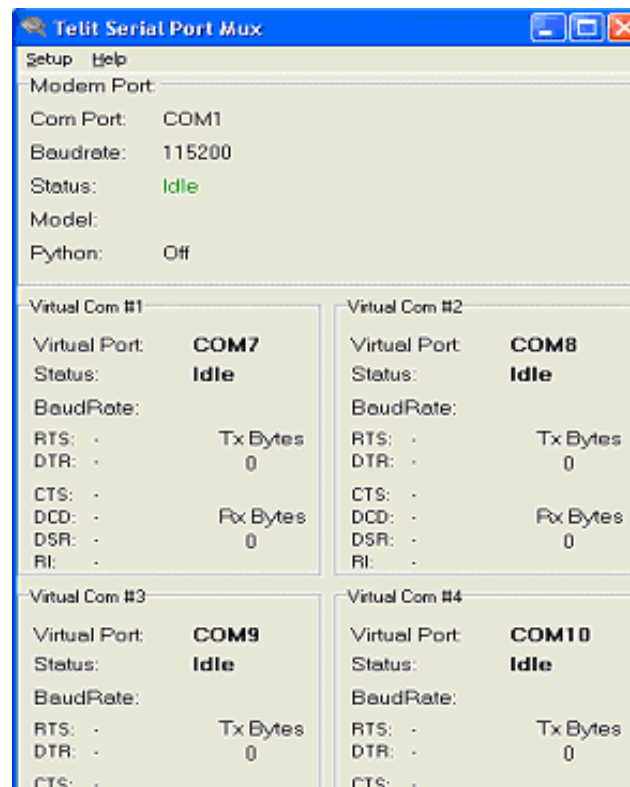

¹⁵ follow the procedure of download and enable of the Python script reported in the paragraph 4.2 and 4.3



Check if the Setup options are the following:

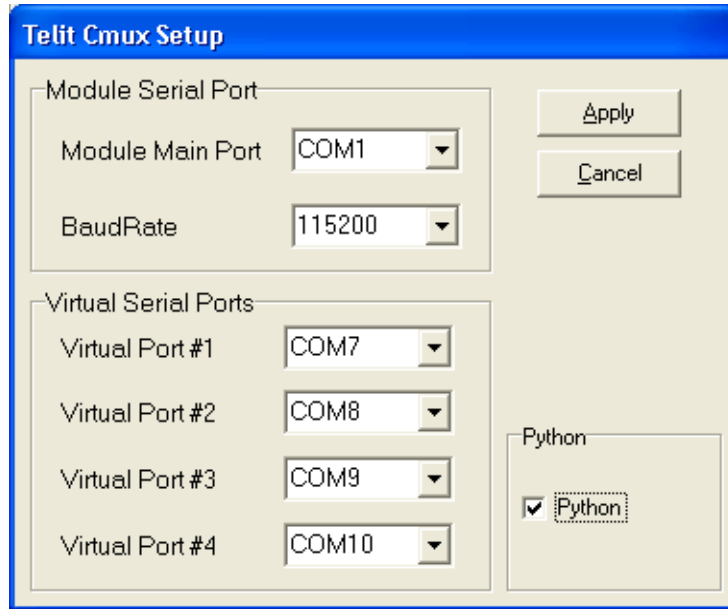

Telit Cmux Setup

Module Serial Port

Module Main Port: COM1

BaudRate: 115200

Virtual Serial Ports

Virtual Port #1: COM7

Virtual Port #2: COM8

Virtual Port #3: COM9

Virtual Port #4: COM10

Python: Python

Apply

Cancel

Set the *Module Main Port* as the real COM port you have available (e.g. COM1 in the figure), check the Python box and then select the Apply button.



Easy Script in Python
80000ST10020a Rev.13 – 2010-12-03

- After this step, you will have 4 new *Telit Serial Port Mux* ports (see *Control Panel – System – Hardware – Device Manager*) as in the figure below:

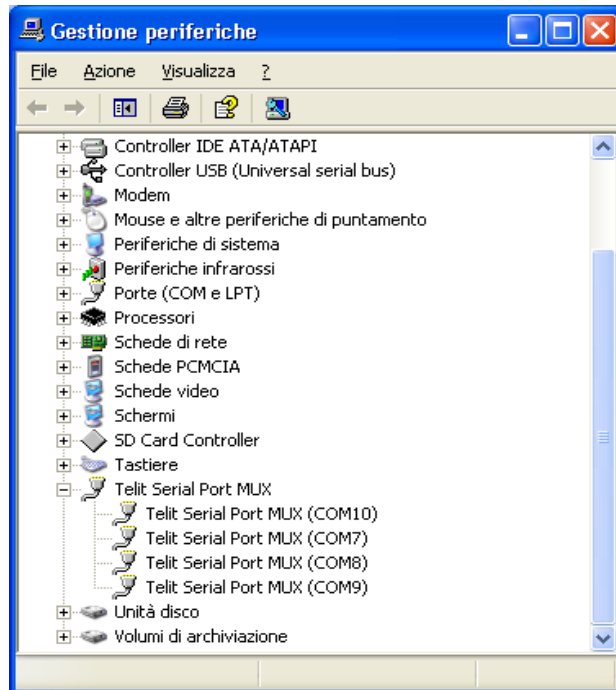

- Run a terminal emulator application (e.g. *Hyper Terminal*) to trace the activity of the Python script, with the following setting:

connected COM	virtual port #4 set in Telit CMUX window (COM10 in the figure)
Bit rate	115 200
Data bits	8
Parity	No parity
Stop bit	1
Flow control	Hardware

In the *Telit Serial Port Mux* window, “Status:” of the Virtual Port#4, after establishing connection in *Hyper Terminal*, will change from *Idle* to *Opened*

- Power on the module and wait for at least 10 seconds without sending any AT command (except AT<Enter>);
- In the *Telit Serial Port Mux* window, “Status:” of the *Modem Port:* will change in the following way (before 10 seconds expired):
- Idle → cycle between Connecting and Error → Connected



Easy Script in Python

80000ST10020a Rev.13 – 2010-12-03

- After 10 seconds you should see the script starting and the debug info appearing on the terminal emulator window.
- If an ERROR messages appears in the Virtual Port #1,2,3,4 boxes, close any application controlling the serial ports and then restart the Telit CMUX application. If this procedure is not sufficient to avoid ERROR message, reset the PC, run again *Telit Serial Port Mux* with the same settings and repeat the procedure as described above.
- If you need to debug the same Python application again, then:
 1. Disconnect the terminal emulator application (eg. *Hyper Terminal*) from the Virtual Port#4 (in this case COM10)
 2. "Status:" of the Virtual Port#4 in the *Telit Serial Port Mux* window, should change from Opened to Idle
 3. Switch off the module
 4. Connect the terminal emulator application to Virtual Port#4 (in this case COM10)
 5. "Status:" of the Virtual Port#4 in the *Telit Serial Port Mux* window¹⁶, should change from Idle to Opened
 6. Switch on the module and wait for the "Status:" of the *Modem Port* in the *Telit Serial Port Mux* window to go connected

¹⁶ If the *Telit Serial Port Mux* application seems to be freezed, please consider that it becomes active after the module is switched on.



5. Python standard functions

In this paragraph you can find detailed description of Python language supported features in Data Terminal Modules. Note that all the functions listed below are available in the Python version 1.5.2+.

5.1. Technical characteristics

5.1.1. General

All Python statements and almost all Python built-in types and functions are supported. See in the table below the features not supported:

complex
float
docstring

Available built-in modules are:

marshal
imp
<u>main</u>
<u>builtin</u>
sys
md5

All others are not supported.



5.2.2. Truth Value Testing

Truth value testing is supported.

5.2.3. Boolean Operations

The following Boolean operations are supported:

<code>x or y</code>
<code>x and y</code>
<code>not x</code>

5.2.4. Comparisons

The following comparisons are supported:

<code><</code>
<code><=</code>
<code>></code>
<code>>=</code>
<code>==</code>
<code><></code>
<code>!=</code>
<code>is</code>
<code>is not</code>



5.2.5. Numeric Types: Integers

The following operations are supported with the integer type:

<code>x + y</code>
<code>x - y</code>
<code>x * y</code>
<code>x / y</code>
<code>x % y</code>
<code>-x</code>
<code>+x</code>
<code>abs(x)</code>
<code>int(x)</code>
<code>long(x)</code>
<code>divmod(x, y)</code>
<code>pow(x, y)</code>
<code>x ** y</code>
<code>x y</code>
<code>x ^ y</code>
<code>x & y</code>
<code>x << n</code>
<code>x >> n</code>
<code>~x</code>

5.2.6. Numeric Types: Long Integers

The following operations are supported with long integers:

<code>x + y</code>
<code>x - y</code>
<code>x * y</code>
<code>x / y</code>
<code>x % y</code>
<code>-x</code>
<code>+x</code>
<code>abs(x)</code>
<code>int(x)</code>
<code>long(x)</code>
<code>divmod(x, y)</code>
<code>pow(x, y)</code>
<code>x ** y</code>
<code>x y</code>
<code>x ^ y</code>
<code>x & y</code>
<code>x << n</code>
<code>x >> n</code>
<code>~x</code>



5.2.7. Numeric Types: Float

Floating point numbers are not supported.

5.2.8. Numeric Types: Complex

Complex numbers are not supported.

5.2.9. Sequence Types: Strings

The following operations are supported with the string type:

<code>x in s</code>
<code>x not in s</code>
<code>s + t</code>
<code>s * n, n * s</code>
<code>s[i]</code>
<code>s[i:j]</code>
<code>len(s)</code>
<code>min(s)</code>
<code>max(s)</code>

The only difference between Python version 1.5.2+ and 1.5.2 is that strings are objects that support the following methods:

<code>s.capitalize()</code>
<code>s.count(sub[, start[, end]])</code>
<code>s.endswith(suffix[, start[, end]])</code>
<code>s.find(sub[, start[, end]])</code>
<code>s.index(sub[, start[, end]])</code>
<code>s.join(seq)</code>
<code>s.lstrip()</code>
<code>s.lower()</code>
<code>s.replace(old, new[, maxsplit])</code>
<code>s.rfind(sub[, start[, end]])</code>
<code>s.rindex(sub[, start[, end]])</code>
<code>s.rstrip()</code>
<code>s.split([sep [,maxsplit]])</code>
<code>s.startswith(prefix[, start[, end]])</code>



<code>s.strip()</code>
<code>s.swapcase()</code>
<code>s.translate(table[, deletechars])</code>
<code>s.upper()</code>

The following attribute is supported:

`__methods__`

For string methods refer to Python 2.0.1 Library Reference for further details.

5.2.10. Sequence Types: Tuples

The following operations are supported with the tuples:

<code>x in s</code>
<code>x not in s</code>
<code>s + t</code>
<code>s * n, n * s</code>
<code>s[i]</code>
<code>s[i:j]</code>
<code>len(s)</code>
<code>min(s)</code>
<code>max(s)</code>

5.2.11. Sequence Types: Lists

The following operations are supported with the lists:

<code>x in s</code>
<code>x not in s</code>
<code>s + t</code>
<code>s * n, n * s</code>
<code>s[i]</code>
<code>s[i:j]</code>
<code>len(s)</code>
<code>min(s)</code>



<code>max(s)</code>
<code>s[i] = x</code>
<code>s[i:j] = t</code>
<code>del s[i:j]</code>
<code>s.append(x)</code>
<code>s.extend(x)</code>
<code>s.count(x)</code>
<code>s.index(x)</code>
<code>s.insert(i, x)</code>
<code>s.pop([i])</code>
<code>s.remove(x)</code>
<code>s.reverse()</code>
<code>s.sort([cmpfunc])</code>

The following attribute is supported:

`__methods__`

5.2.12. Mapping Types: Dictionaries

The following operations are supported with the dictionaries:

<code>len(a)</code>
<code>a[k]</code>
<code>a[k] = x</code>
<code>del a[k]</code>
<code>a.clear()</code>
<code>a.copy()</code>
<code>a.has_key(k)</code>
<code>a.items()</code>
<code>a.keys()</code>
<code>a.update(b)</code>
<code>a.values()</code>
<code>a.get(k[, x])</code>

The following attribute is supported:

`__methods__`



5.2.17. Other Built-in Types: Methods

Methods objects are supported with the following attributes:

<code>__name__</code>
<code>__self__</code>

5.2.18. Other Built-in Types: Type Objects

Type objects are supported.

5.2.19. Other Built-in Types: Null Object

Null object is supported.

5.2.20. Other Built-in Types: Ellipsis Object

Ellipsis object is supported.

5.2.21. Other Built-in Types: Buffer Objects

Buffer objects are supported.

5.2.22. Other Built-in Types: Range Objects

Range objects are supported.



5.2.23. Other Built-in Internal Types: Code Objects

Code objects and code object execution is supported with the following attributes:

co_argcount
co_nlocals
co_stacksize
co_flags
co_code
co_consts
co_names
co_varnames
co_filename
co_name
co_firstlineno
co_lnotab

5.2.24. Other Built-in Internal Types: Frame Objects

Frame objects are supported with the following attributes:

f_back
f_code
f_builtins
f_globals
f_locals
f_lasti
f_lineno
f_restricted
f_trace
f_exc_type
f_exc_value
f_exc_traceback

5.2.25. Other Built-in Internal Types: Traceback Objects

Traceback objects are supported with the following attributes:

tb_next
tb_frame
tb_lasti
tb_lineno



RemovedFeatureError is an exception added in Python version 1.5.2+. RemovedFeatureError is raised when trying to use floats or complex that are not supported.

Exception are strings objects. If file exceptions.py is downloaded to Data Terminal Module Python than module exceptions is automatically imported at the scripts start and exceptions are class objects.

5.2.28. Built-in Functions

The following built-in functions are supported:

abs(x)
cmp(x, y)
round(x [, n]) (returns error)
vars([object])
ord(c)
__import__(name[, globals[, locals[, fromlist]])
callable(object)
coerce(x, y)
compile(string, filename, kind)
complex(real [, imag]) (returns error)
delattr(object, name)
divmod(a, b)
eval(expression[, globals[, locals]])
execfile(file[, globals[, locals]])
filter(function, list)
float(x) (returns error)
globals()
input([prompt])
int(x)
intern(string)
issubclass(class1, class2)
locals()
long(x)
oct(x)
open(filename[, mode[, bufsize]])
raw_input([prompt])
reload(module)



5.2.30. Built-in Modules: imp

Built-in imp module is supported with the following methods:

find_module(name[, path])
get_magic()
get_suffixes()
load_module(name, file, filename, description)
new_module(name)

The following constants are supported:

PY_SOURCE
PY_COMPILED
C_BUILTIN
PY_FROZEN

5.2.31. Built-in Modules: __main__

Built-in __main__ module is supported.

5.2.32. Built-in Modules: __builtin__

Built-in __builtin__ module is supported.



5.2.33. Built-in Modules: sys

Built-in sys module is supported with the following methods:

<code>exc_info()</code>
<code>exit([arg])</code>
<code>getrefcount(object)</code>
<code>setcheckinterval(interval)</code>

The following variables are supported:

<code>stdin</code>
<code>stdout</code>
<code>stderr</code>
<code>__stdin__</code>
<code>__stdout__</code>
<code>__stderr__</code>
<code>version</code>
<code>hexversion</code>
<code>copyright</code>
<code>platform</code>
<code>executable</code>
<code>prefix</code>
<code>exec_prefix</code>
<code>maxint</code>
<code>builtin_module_names</code>
<code>removed_features</code>
<code>argv</code>
<code>exc_type</code>
<code>exc_value</code>
<code>exc_traceback</code>
<code>exitfunc</code>
<code>last_type</code>
<code>last_value</code>
<code>last_traceback</code>
<code>modules</code>
<code>path</code>
<code>tracebacklimit</code>

The variables `hexversion` and `removed_features` are variables added in Python version 1.5.2+. "Hexversion" is the version number encoded as a single integer. This is called 'hexversion' since it only really looks meaningful when viewed as the result of passing it to the built-in `hex()` function. "Removed_features" is a tuple of the strings "ComplexType" "FloatType" and "DocStrings".



5.2.34. Built-in Modules: md5

Built-in md5 module is supported with the following functions:

<code>new([arg])</code>
<code>md5([arg])</code>

The following methods are supported:

<code>update(arg)</code>
<code>digest()</code>
<code>copy()</code>

5.2.35. Built-in Modules: binascii

Built-in binascii module is supported with the following functions:

<code>a2b_uu(string)</code>
<code>b2a_uu(data)</code>
<code>a2b_base64(string)</code>
<code>b2a_base64(data)</code>
<code>a2b_hqx(string)</code>
<code>rledecode_hqx(data)</code>
<code>rlecode_hqx(data)</code>
<code>b2a_hqx(data)</code>
<code>crc_hqx(data, crc)</code>

The following exceptions are supported:

<code>Error</code>
<code>Incomplete</code>

Available in version 10.00.xx3.

5.2.36. Library Modules

Most of Python Library Modules are not supported because they depend on Operative System. Basically if a library module imports OS that module is not supported. Some library modules do not depend on Operative System and are supported. An example is string.py.



6. Python non standard functions

6.1. __builtin__ non standard functions

6.1.1. Non standard function: unlink

This function is used to remove (delete) the file `filename`. The argument, `filename`, is the file name to be removed (deleted).
If the file does not exist or an error occurs an exception is raised.

Example:

```
unlink("test.txt")
```

6.1.2. Non standard function: rename

This function is used to rename the file `oldfilename` to `newfilename`. The first argument, `oldfilename`, is the file name to be renamed, the second argument, `newfilename`, is the new file name.

If the file `oldfilename` does not exist or an error occurs an exception is raised.
If the file `newfilename` exists, it will be silently overwritten.

Example:

```
rename("test1.txt", "test2.txt")
```

6.1.3. Non standard function: flashflush

This function is used to flush flash writing operations. The Python script execution is stopped until all queued data is written on flash.

Example:

```
unlink("test.txt")  
flashflush()
```



7. Python notes

7.1. Memory Limits

In order to prevent *memory error*, in phase of compilation or execution of the script, we advise you to consider the following limits:

- allocated memory for each variable
- number of the variables that can cause RAM overflow.

The memory available on Telit Python modules includes:

- around 2MB of Non Volatile Memory for the user scripts and data
- 1.2 MB RAM reserved for Python engine usage
- 16KB of memory for each variable

In order to give rough idea of the impact of these constrains consult the table below that contains limits for different types of variables. Please note that these limits are estimated values and should be used only to give general information in Python script development.

Type of variable	number of elements ¹⁷	example
string	16 000	'data'
list	4 000	[23,'data','c']
tuple	4 000	(23,'data','c')
range	4 000	range(3)=[0,1,2]
dictionary	worst condition 682	{ 'aaa':1000, 'bbb':1001}



NOTE:

each element of list, tuple, range, or dictionary has up to 16KB of memory available.



8. List of acronyms

Abbreviation	Description
ACM	Accumulated Call Meter
ASCII	American Standard Code for Information Interchange
AT	Attention Commands
CB	Cell Broadcast
CBS	Cell Broadcasting Service
CCM	Call Control Meter
CLIP	Calling Line Identification Presentation
CLIR	Calling Line Identification Restriction
CMOS	Complementary Metal-Oxide Semiconductor
CR	Carriage Return
CSD	Circuit Switched Data
CTS	Clear To Send
DAI	Digital Audio Interface
DCD	Data Carrier Detected
DCE	Data Communications Equipment
DRX	Data Receive
DSR	Data Set Ready
DTA	Data Terminal Adaptor
DTE	Data Terminal Equipment
DTMF	Dual Tone Multi Frequency
DTR	Data Terminal Ready
EMC	Electromagnetic Compatibility
ETSI	European Telecommunications Equipment Institute
FTA	Full Type Approval (ETSI)
GPRS	General Radio Packet Service
GPIO	General Purpose Input Output
GSM	Global System for Mobile communication
HF	Hands Free
IIC	Inter Integrated Circuit
IMEI	International Mobile Equipment Identity
IMSI	International Mobile Subscriber Identity
IRA	International Reference Alphabet
ITU	International Telecommunications Union
IWF	Inter-Working Function
LCD	Liquid Crystal Display



LED	Light Emitting Diode
LF	Linefeed

