

U\_B2B\_Connectors  
B2B\_Connectors.SchDoc

U\_xmod  
xmod.SchDoc

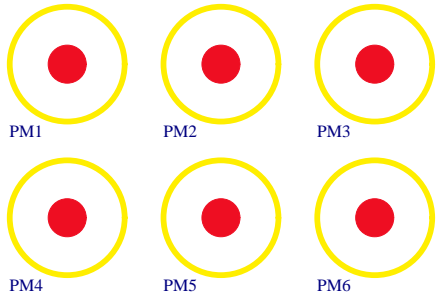

Mount.Hole 3.2mm Mount.Hole 3.2mm Mount.Hole 3.2mm Mount.Hole 3.2mm Mount.Hole 3.2mm Mount.Hole 3.2mm Mount.Hole 3.2mm

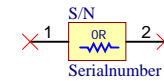
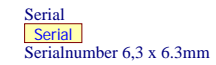
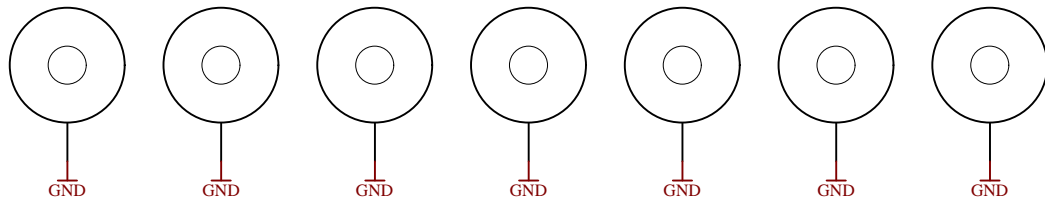

Title: <b>Overview</b>		
A4	Number: <b>TEB0714 default</b>	Rev. <b>01</b>
Date: <b>2016-05-25</b>	Copyright: <b>Trenz Electronic GmbH</b>	Page1 of 3
Filename: <b>TET0714.SchDoc</b>		

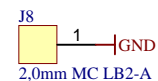
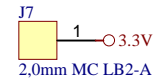
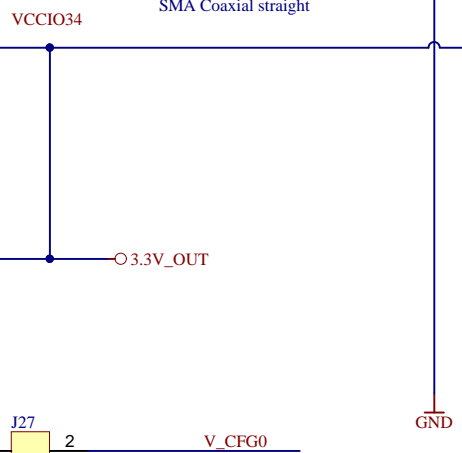
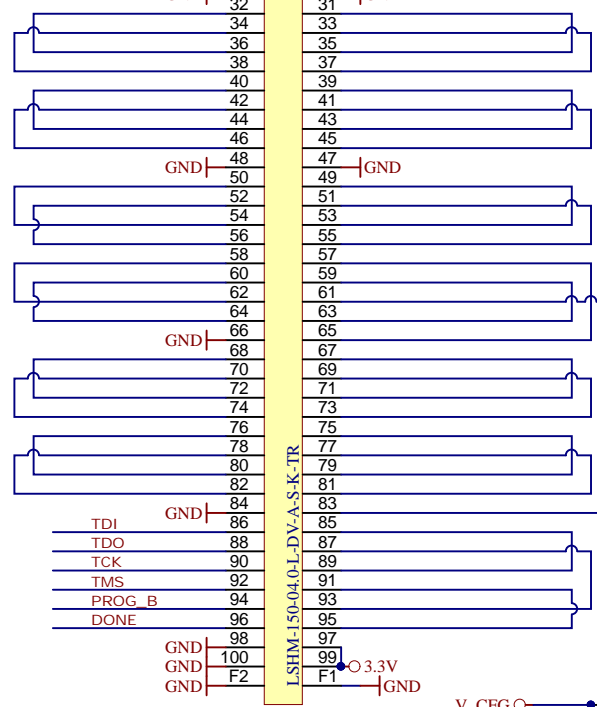
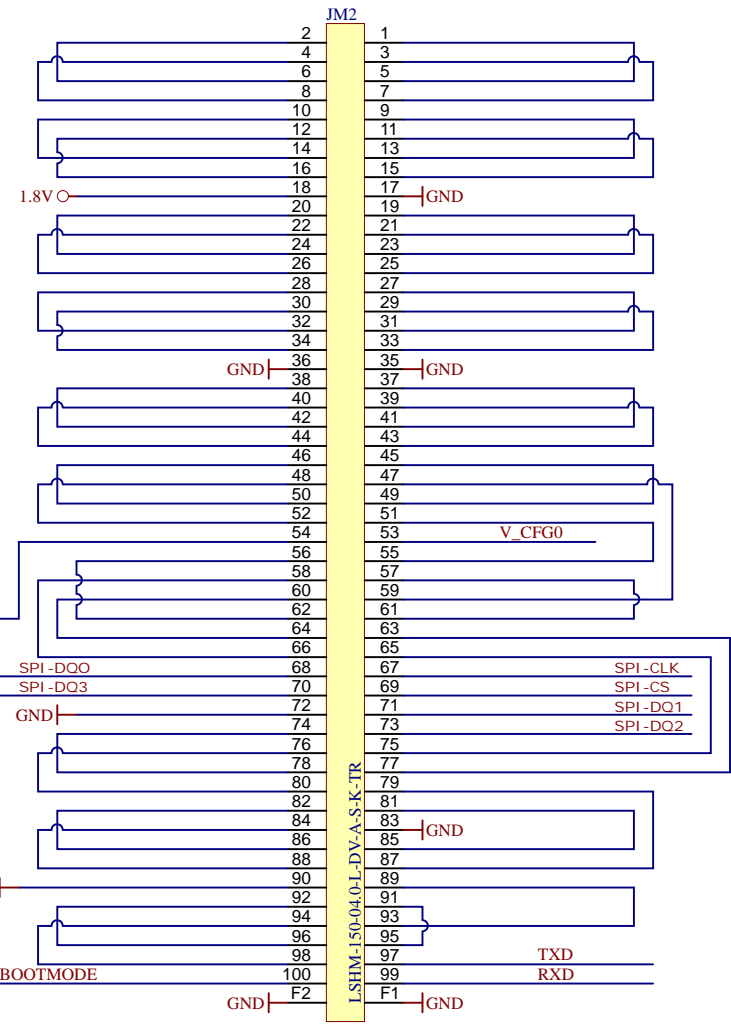
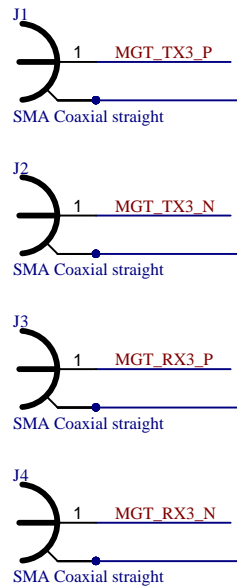
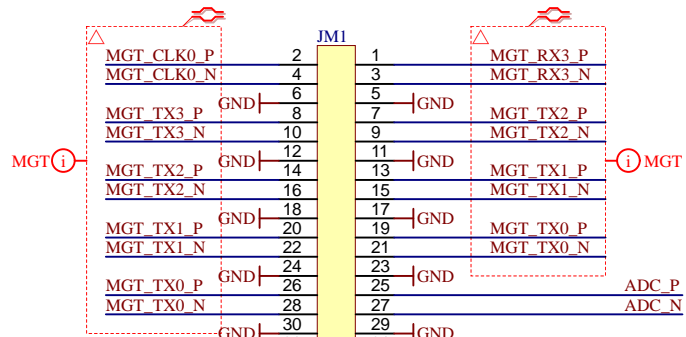

Title: B2B Connector		
A4	Number: TEB0714 default	Rev. 01
Date: 2016-05-25	Copyright: Trenz Electronic GmbH	Page2 of 3
Filename: B2B_Connectors.SchDoc		

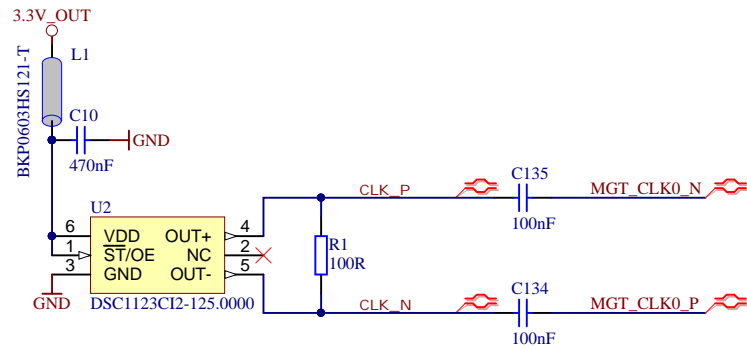

XMOD-FT2232H header: JTAG and UART

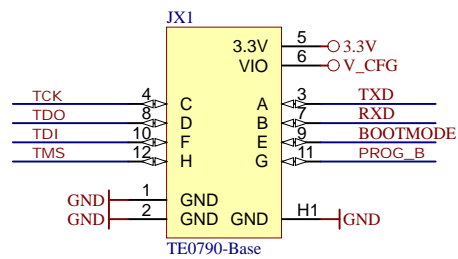

Title: XMOD		
A4	Number: TEB0714 default	Rev. 01
Date: 2016-05-25	Copyright: Trenz Electronic GmbH / TT	Page3 of 3
Filename: xmod.SchDoc		